

~~SECRET // REL TO USA, FVEY~~

DEPARTMENT OF THE ARMY  
THIRD ARMY / UNITED STATES ARMY CENTRAL  
1 GABRESKI DRIVE  
SHAW AIR FORCE BASE, SC 29152-5202

ACCG (RN 15-6b1)

MEMORANDUM FOR BG Lance G. Curtis, Deputy Commanding General – Operational Command Post (OCP), 1st Theater Sustainment Command, Camp Arifjan, Kuwait

SUBJECT: Appointment as Investigating Officer

1. (~~S//REL TO USA, FVEY~~) Appointment. You are hereby appointed as an Investigating Officer (IO) pursuant to Army Regulation (AR) 15-6 (*Procedures for Administrative Investigations and Boards of Officers*). Pursuant to this duty, you will conduct an investigation into the facts and circumstances surrounding the attack upon U.S. forces located at Hamid Karzai International Airport (HKIA), Kabul, Afghanistan on 26 August 2021. Prior to beginning your investigation, you must contact your legal advisor as directed in paragraph 4 below. **This investigation is your primary duty and takes precedence over all other duties.**

2. (~~S//REL TO USA, FVEY~~) Background. On 26 August 2021, while U.S. forces were conducting a noncombatant evacuation operation (NEO) out of HKIA, there were purportedly multiple explosions in the vicinity of HKIA, which resulted in the deaths of thirteen Servicemembers.

3. (~~S//REL TO USA, FVEY~~) Scope. Your investigation will address the following matters:

a. (~~S//REL TO USA, FVEY~~) Actions before, during, and after the attack.

b. (~~S//REL TO USA, FVEY~~) Force protection, specifically including pertinent issues associated with:

(1) (~~S//REL TO USA, FVEY~~) Force posture, and

(2) (~~S//REL TO USA, FVEY~~) Gate operations.

c. (~~S//REL TO USA, FVEY~~) Readiness.

d. (~~S//REL TO USA, FVEY~~) Leadership.

e. (~~S//REL TO USA, FVEY~~) Medical considerations.

f. (~~S//REL TO USA, FVEY~~) Chronology/timeline of events.

~~SECRET // REL TO USA, FVEY~~

ACCG (RN 15-6b1)  
SUBJECT: Appointment as Investigating Officer

4. (U) Legal Orientation.

a. (U) Prior to beginning your investigation, you will receive a legal briefing from (b)(6) (b)(3)130b, (b)(6), 1TSC OCP. He may be contacted at DSN: (b)(3)130b, (b)(6) or by email at (b)(3)130b, (b)(6). You may and should obtain legal advice from your legal advisor frequently throughout your investigation.

b. (U) You will consult with your legal advisor regarding all aspects of this investigation, including development of an investigative plan; determining whether witnesses need to be advised of their rights under the U.S. Constitution, Article 31 of the UCMJ, or based on their employment situation; and preparing findings and recommendations. You are directed to utilize and adhere to any templates provided by the legal advisor.

c. (U) Should you determine in the context of your investigation that a Soldier's status has changed from favorable to unfavorable, as defined in AR 600-8-2, *Suspension of Favorable Personnel Actions (Flag)*, you will coordinate with the appropriate officials to initiate the proper flag of said Soldier's personnel file.

5. (U) Procedures. No respondent has been designated in this matter. Accordingly, you will use procedures applicable to administrative investigations set forth in AR 15-6, chapters 3 and 4. Upon completion of this investigation, you will complete a report of investigation that is consistent with guidance provided in AR 15-6 and from your legal advisor. When completed, you will provide this report to the legal advisor, who will arrange for a legal review. This section provides specific procedures you will follow in conducting the investigation.

a. (U) The purpose of an AR 15-6 investigation is to elicit facts. Such facts may be obtained from a number of sources, including witness statements and electronic and other documentary and real (e.g., physical) evidence. You will gather any documents, recordings, videos, or other products or objects that you consider relevant to ascertaining the facts and circumstances you are charged with investigating. Your legal advisor can assist in determining whether you should retain original documents/objects or whether copies, including facsimiles, photographs or videos of such documents/objects, will suffice. All relevant documents and witness statements will be included with your report and reflected on the index described below.

b. (U) Witness statements will be reduced to writing on and sworn to utilizing the DA Form 2823, Sworn Statement. If witness statements are not taken on a DA Form 2823, you may need to provide such witness(es) with a Privacy Act statement before you solicit any information. If such an instance arises, you will contact your legal advisor for advice.

ACCG (RN 15-6b1)

SUBJECT: Appointment as Investigating Officer

c. (U) Prior to questioning any Soldier whom you suspect of having committed a criminal offense, you must advise that person of his or her rights under Article 31 of the Uniform Code of Military Justice. Document your rights advisement and the individual's election of rights on DA Form 3881, Rights Warning Procedure/Waiver Certificate.

d. (U) Likewise, civilians cannot be ordered to incriminate themselves. While the DA Form 3881 may also be used to advise civilians of their rights, should you believe that a civilian witness – who is also a Federal Government civilian employee – may have testimony or evidence that would incriminate themselves, you will contact your legal advisor before proceeding with any interview of said witness(es).

e. (U) Your report should address all matters specified in paragraph 3, with reference to specific points of evidence, and should be thorough. Based on your findings, you may also make recommendations as to what changes, if any, are needed in terms of policy, procedures, resources, doctrine, training, and leadership to avoid incidents of this nature in the future, as well as recommendations consistent with the findings concerning other facts or circumstances your investigation revealed. Each recommendation will cite to the finding that supports it, and should comport with the guidance in AR 15-6.

f. (U) The completed report of your investigation will include:

- (1) (U) This memorandum of appointment;
- (2) (U) A completed DA Form 1574;
- (3) (U) A memorandum for record with your findings and recommendations;
- (4) (U) An index of exhibits;
- (5) (U) All exhibits labeled in successive order; and
- (6) (U) Any copies of relevant investigations or other written products from sister services or foreign partners, as applicable.

g. (U) If you discover other items of concern not previously known or described in this memorandum, you will make a reasonable inquiry into such items as will provide a clearer picture. If such items of concern appear to be completely unrelated, you will prepare a short, separate memo on the subject and forward to me, through the legal advisor, for consideration.

h. (U) Additionally, you may request through your legal advisor the appointment of Assistant IOs, as necessary, to help question witnesses, take sworn statements, and otherwise work to gather evidence. I delegate the approval authority for Assistant IOs to the Staff Judge Advocate, United States Army Central (USARCENT).

ACCG (RN 15-6b1)  
SUBJECT: Appointment as Investigating Officer

6. (~~S//REL TO USA, FVEY~~) Suspense. The suspense date is 1 October 2021. Submit the full investigation, including evidence and associated documentation, to me, through the OSJA, USARCEN, no later than the suspense date. Any requests for extension concerning this investigation will be forwarded, through me, to the Commander, USCENCOM, for approval. You will include any requests for extension, and any action (approval or disapproval) regarding those requests, in the report of investigation.

(b)(6)

RONALD P. CLARK  
Lieutenant General, USA  
Commanding



DEPARTMENT OF THE ARMY  
3RD SUSTAINMENT COMMAND (EXPEDITIONARY)  
CAMP ARIFJAN, KUWAIT  
APO, AE 09366

ACTS-SCK-DO

20 September 2021

MEMORANDUM THRU LTG Ronald P. Clark, Commander, U.S. Army Central Command, Shaw Air Force Base, SC, 29152

MEMORANDUM FOR Gen. Kenneth McKenzie Jr., Commander, U.S. Central Command, 7115 South Boundary Boulevard, MacDill Air Force Base, FL 33621

SUBJECT: (~~S//REL USA, FVEY~~) Request for Extension of AR 15-6 Informal Investigation, Facts and Circumstances Surrounding the Attack at Abbey Gate, Hamid Karzai International Airport (HKIA) on 26 August 2021

1. (~~S//REL USA, FVEY~~) BLUF: I respectfully request an extension to complete this investigation no later than 22 October 2021 in order to properly gather the appropriate documents, conduct personal interviews with appropriate witnesses across five countries, and properly address the scope and breadth of this request given the sensitive and classified nature of the matters involved.

2. (~~S//REL USA, FVEY~~) On the evening of 17 September 2021, I received the appointment memorandum. I was directed to complete my investigation no later than 1 October 2021, a two week suspense.

3. (~~S//REL USA, FVEY~~) Since my appointment, I have put together an investigative team, gathered initial facts, located relevant witnesses, and developed a plan to thoroughly address the matters set forth in the appointment order (enclosure 1). Planning and analysis has revealed additional time is required to ensure an investigation of such monumental importance to our nation, and military services, is done right.

a. (~~S//REL USA, FVEY~~) Units. Personnel from multiple units, not counting partner nations, need to be interviewed as well as a number of individuals who have dispersed since 26 August. These include personnel from CENTCOM, 82d Airborne Division, USFOR-A/JSOTF-A, JTF-CR (51-5), 24th MEU, SPMAGTF, G Co 2-1BN, 3d Medical Command, Mortuary Affairs Team, and 8th POG (PsOps). In total, we anticipate well over fifty interviews. This list will likely change as the TASKORG is analyzed and new information is provided.

b. (~~S//REL USA, FVEY~~) Locations. With the number of personnel and units across multiple services, a number of these units have re-deployed or have had elements directed to various locations including Kuwait (multiple installations, Qatar, Bahrain, Saudi Arabia, and the United States (CA and NC). Travel alone will take approximately eight out of the fourteen allotted days given the potential issues that arise with travel during heightened Covid-19 restrictions.

c. (~~S//REL USA, FVEY~~) Investigation Integrity. I also would like the primary investigation team to conduct the majority of these interviews in person due to the sensitive nature of the incident, the need to interact with exhibits/pictures during the interview, and to ensure the integrity of the classified investigation. I also seek to avoid appointing additional investigating

ACTS-SCK-DO

SUBJECT: (~~S//REL USA, FVEY~~) Request for Extension of AR 15-6 Informal Investigation, Facts and Circumstances Surrounding the Attack at Abbey Gate, Hamid Karzai International Airport (HKIA) on 26 August 2021

officers who do not have the depth and breadth of knowledge that will be developed by the team, or which may increase the potential for the investigation to be compromised.

4. (~~S//REL USA, FVEY~~) For the above reasons, I request an extension to complete my investigation no later than 22 October 2021.

5. (~~S//REL USA, FVEY~~) The point of contact for this memorandum is the undersigned at

(b)(3)130b, (b)(6)

legal advisor, at

(b)(6)

3 Encls

- 1. Appointment Order, 17 September 2021
- 2. Proposed Investigative Calendar
- 2. Draft Investigative Plan

(b)(6) LANCE G. CURTIS  
Brigadier General, USA  
Investigating Officer

Recommendation:

Approval     Disapproval

RONALD P. CLARK  
Lieutenant General, USA  
Commanding

The request for extension is hereby:

Approved     Disapproved

KENNETH MCKENZIE JR.  
General, USMC  
Commanding

**From:** (b)(3)130b, (b)(6)  
**To:**  
**Subject:** FW: ~~SECRET~~ ARCENT AR 15-6 Request for Extension (~~SECRET~~)  
**Date:** Wednesday, September 22, 2021 10:15:58 AM

Classification: ~~SECRET~~

We don't think any paperwork is necessary. An email concurrence is fine for a 15-6 extension.

v/r

(b)(3)130b, (b)(6)

Classified By: (b)(6) USARMY CENTCOM CCJA (USA)  
Derived From: USCENTCOM SCG, CCR 380-14, 12 April 2021.  
Declassify On: 2046-09-22  
Classification: ~~SECRET~~

-----Original Message-----

From: (b)(6) USN CENTCOM CCJA (USA)  
Sent: Wednesday, September 22, 2021 9:13 AM  
To: (b)(6) USARMY CENTCOM CCJA (USA)  
(b)(3)130b, (b)(6)  
Cc: (b)(6) CENTCOM CCJA (USA)  
(b)(3)130b, (b)(6) (b)(6) USMC CENTCOM CCJA (USA) (b)(3)130b, (b)(6)  
Subject: FW: ~~SECRET~~ ARCENT AR 15-6 Request for Extension (~~SECRET~~)

Classification: ~~SECRET~~

Classified By: (b)(6) USN CENTCOM CCJA (USA)  
Derived From: USCENTCOM SCG, CCR 380-14, 12 April 2021.  
Declassify On: 2046-09-22  
Classification: ~~SECRET~~

-----Original Message-----

From: McKenzie, Kenneth F Jr Gen USMC CENTCOM CCCG (USA)  
Sent: Wednesday, September 22, 2021 6:01 AM  
To: Clark, Ronald P LTG USARMY USARCENT (USA)  
(b)(3)130b, (b)(6)  
Cc: Malloy, James Joseph VADM USN CENTCOM CCCG (USA)  
(b)(3)130b, (b)(6); Frank, Patrick D MG USARMY CENTCOM CCCG (USA) (b)(3)130b, (b)(6); (b)(6) USN CENTCOM CCJA (USA) (b)(3)130b, (b)(6); (b)(6) CIV CENTCOM CCJA (USA) (b)(3)130b, (b)(6)  
Subject: RE: ~~SECRET~~ ARCENT AR 15-6 Request for Extension (~~SECRET~~)

Classification: ~~SECRET~~

Approved -- paperwork will follow.

r/

M4

Classified By: McKenzie, Kenneth F Jr Gen USMC CENTCOM CCG (USA)

Derived From: USCENTCOM SCG, CCR 380-14, 12 April 2021.

Declassify On: 2046-09-22

Classification: ~~SECRET~~

-----Original Message-----

From: Clark, Ronald P LTG USARMY USARCENT (USA)

Sent: Tuesday, September 21, 2021 6:08 PM

To: McKenzie, Kenneth F Jr Gen USMC CENTCOM CCG (USA)

(b)(3)130b, (b)(6)

Cc: Malloy, James Joseph VADM USN CENTCOM CCG (USA)

(b)(3)130b, (b)(6)

; Frank, Patrick D MG USARMY CENTCOM CCG

(USA) (b)(3)130b, (b)(6) ; (b)(6) USN CENTCOM

CCJA (USA) (b)(3)130b, (b)(6) ; (b)(6)

CIV CENTCOM CCJA (USA) (b)(3)130b, (b)(6)

Subject: ARCENT AR 15-6 Request for Extension (~~SECRET~~)

CLASSIFICATION: ~~SECRET~~

Sir,

You will receive a request from BG Lance Curtis, our IO for the AR 15-6 investigation on Abby Gate for an extension from the original suspense of 1 October to NLT 22 October.

The extension provides the IO adequate time to collect documentation, interview and take sworn statements from leaders and witnesses across 5 countries, and to prepare his report with a legal review from our Command Judge Advocate.

I recommend approval of the request and stand by for your questions if any.

VR,

Ron

Patton's Own!

CLASSIFICATION: ~~SECRET~~



~~SECRET//REL TO USA, FVEY~~



**UNITED STATES MARINE CORPS**  
U.S. MARINE CORPS FORCES, CENTRAL COMMAND  
7115 SOUTH BOUNDARY BOULEVARD  
MACDILL AIR FORCE BASE, FLORIDA 33621-5101

IN REPLY REFER TO:  
5800  
SJA  
17 Sep 21

From: **Commander, U.S. Marine Corps Forces Central Command**  
To: (b)(3)130b, (b)(6) 1020762710/8041 USMCR

Subj: (~~S//REL TO USA, FVEY~~) INVESTIGATION INTO THE FACTS AND CIRCUMSTANCES SURROUNDING THE ATTACK AT ABBEY GATE, HAMID KARZAI INTERNATIONAL AIRPORT (HKIA) ON 26 AUGUST 2021

Ref: (a) Army Regulation 15-6  
(b) Deputy Commander, U.S. Central Command memo of 15 Sep 21  
(c) Commanding General, U.S. Army Central memo of 17 Sep 21  
(d) JAGINST 5800.7G (JAGMAN), Chapter II

1. (~~S//REL TO USA, FVEY~~) Per references (a) and (b) and by reference (c), Commanding General, U.S. Army Central has appointed Brigadier General Lance G. Curtis, U.S. Army, to conduct an investigation into the facts and circumstances surrounding the attack upon U.S. forces located at the Abbey Gate at HKIA, Kabul, Afghanistan on 26 August 2021. The investigation will be a holistic review of the facts and circumstances surrounding the attack, to include an in-depth examination of all relevant aspects which gave rise to the attack and the tactical-level actions of U.S. personnel, gate operations, force protection and posture, readiness, leadership, and all other actions before, during, and after the attack.

2. (~~S//REL TO USA, FVEY~~) Per references (a) and (d), this letter appoints you as an assistant investigating officer to assist Brigadier General Curtis and his investigative team with conducting the aforementioned investigation.

3. (~~S//REL TO USA, FVEY~~) Deputy Commander, U.S. Central Command has directed that this investigation be completed no later than 1 October 2021 unless granted additional time by Commander, U.S. Central Command. This appointment is your primary duty and remains as such until the investigation is complete.

4. (U) The point of contact for this matter is the Staff Judge Advocate (b)(3)130b, (b)(6)  
(b)(3)130b, (b)(6) who can be reached at SVOIP (b)(3)130b, (b)(6)

(b)(3)130b, (b)(6)

Copy to:  
MARCENT SJA  
ARCENT SJA

~~SECRET//REL TO USA, FVEY~~



DEPARTMENT OF THE ARMY  
HEADQUARTERS, 1ST THEATER SUSTAINMENT COMMAND  
OPERATIONAL COMMAND POST  
CAMP ARIFJAN, KUWAIT  
APO, AE 09366

ACTS-SJA

2 October 2021

(b)(3)130b, (b)(6)

MEMORANDUM FOR (b)(3)130b, (b)(6) U.S. Army Central, 1 Gabreski Drive, Shaw Air Force Base, SC 29152

SUBJECT: ~~(S//REL USA, FVEY)~~ Assistant Investigating Officer Appointment for AR 15-6 Informal Investigation, Facts and Circumstances Surrounding the Attack at Abbey Gate, Hamid Karzai International Airport (HKIA) on 26 August 2021

1. ~~(S//REL USA, FVEY)~~ BLUF: I respectfully request you appoint two additional investigating officers (IOs) to assist with interviewing and transcribing statements for the interviews to be conducted from 2 – 22 October 2021.
2. ~~(S//REL USA, FVEY)~~ Pursuant to para 5.h. of the ARCENT appointment memo, you have the ability to appoint additional investigators to assist with the above referenced investigation. After the initial phase of interviews for the witnesses in the CENTCOM AOR, it was determined that the current team is inadequate to both interview and transcribe the number of remaining witnesses in the allotted time. Therefore, the appointed IO, BG Lance Curtis, identified the following individuals to assist as additional IOs:

a. (b)(3)130b, (b)(6)

b. (b)(3)130b, (b)(6)

3. ~~(S//REL USA, FVEY)~~ The point of contact for this memorandum is BG Lance Curtis at (b)(3)130b, (b)(6) or the undersigned at (b)(6) and (b)(3)130b, (b)(6)

(b)(3)130b, (b)(6)

~~SECRET//REL TO USA, FVEY~~



**UNITED STATES MARINE CORPS**  
U.S. MARINE CORPS FORCES, CENTRAL COMMAND  
7115 SOUTH BOUNDARY BOULEVARD  
MACDILL AIR FORCE BASE, FLORIDA 33621-5101

IN REPLY REFER TO:  
5800  
SJA  
21 Sep 21

From: Commander, U.S. Marine Corps Forces Central Command  
To: [redacted] 1248108700/1302 USMC

Subj: (~~S//REL TO USA, FVEY~~) INVESTIGATION INTO THE FACTS AND CIRCUMSTANCES SURROUNDING THE ATTACK AT ABBEY GATE, HAMID KARZAI INTERNATIONAL AIRPORT (HKIA) ON 26 AUGUST 2021

Ref: (a) Army Regulation 15-6  
(b) Deputy Commander, U.S. Central Command memo of 15 Sep 21  
(c) Commanding General, U.S. Army Central memo of 17 Sep 21  
(d) JAGINST 5800.7G (JAGMAN), Chapter II

1. (~~S//REL TO USA, FVEY~~) Per references (a) and (b) and by reference (c), Commanding General, U.S. Army Central has appointed Brigadier General Lance G. Curtis, U.S. Army, to conduct an investigation into the facts and circumstances surrounding the attack upon U.S. forces located at the Abbey Gate at HKIA, Kabul, Afghanistan on 26 August 2021. The investigation will be a holistic review of the facts and circumstances surrounding the attack, to include an in-depth examination of all relevant aspects which gave rise to the attack and the tactical-level actions of U.S. personnel, gate operations, force protection and posture, readiness, leadership, and all other actions before, during, and after the attack.

2. (~~S//REL TO USA, FVEY~~) Per references (a) and (d), this letter appoints you as an assistant investigating officer to assist Brigadier General Curtis and his investigative team with conducting the aforementioned investigation.

3. (~~S//REL TO USA, FVEY~~) Deputy Commander, U.S. Central Command has directed that this investigation be completed no later than 1 October 2021 unless granted additional time by Commander, U.S. Central Command. This appointment is your primary duty and remains as such until the investigation is complete.

4. (U) The point of contact for this matter is the Staff Judge Advocate, [redacted] who can be reached at SVOIP [redacted]

[redacted]

Copy to:  
MARCENT SJA  
ARCENT SJA

~~SECRET//REL TO USA, FVEY~~

~~SECRET // REL TO USA, FVEY~~

DEPARTMENT OF THE ARMY  
 THIRD ARMY / UNITED STATES ARMY CENTRAL  
 1 GABRESKI DRIVE  
 SHAW AIR FORCE BASE, SC 29152-5202

ACCG (RN 15-6b1)

SEP 27 2021

MEMORANDUM FOR BG Lance G. Curtis, Deputy Commanding General – Operational Command Post (OCP), 1st Theater Sustainment Command, Camp Arifjan, Kuwait

SUBJECT: Appointment of Assistant Investigating Officers

1. (~~S//REL TO USA, FVEY~~) Appointment. The below-named individuals are hereby appointed as Assistant Investigating Officers (IO) to BG Lance G. Curtis, pursuant to Army Regulation (AR) 15-6 (*Procedures for Administrative Investigations and Boards of Officers*) and the original IO appointment memorandum dated 17 September 2021. The original appointment directed BG Curtis to conduct an investigation into the facts and circumstances of the 26 August 2021 attack on the Abbey Gate to Hamid Karzai International Airport (HKIA), Kabul, Afghanistan.

2. (U) Process and Procedure. Assistant IOs are appointed under the provision of AR 15-6, para. 2-3.c, "to provide special technical knowledge, or to assist the appointed IO with conducting interviews and performing other investigative tasks." The below named IOs will work for and with BG Curtis, and they will follow all guidance given in the 17 September 2021 appointment memorandum:

- a. (U) [redacted] (USMC), Marine Coordination Element – Qatar (MCEQ), U.S. Marine Corps Forces Central Command (MARCENT);
- b. (U) [redacted] MCEQ, MARCENT;
- c. (U) [redacted] 3d Expeditionary Sustainment Command (3ESC), Kuwait;
- d. (U) [redacted] 3ESC, Kuwait; and
- e. (U) [redacted] 3ESC, Kuwait.

3. (U) The point of contact for this memorandum is the USARCENT SJA, [redacted] who may be reached via SIPR email at [redacted] or SVOIP at [redacted].

[redacted]

RONALD P. CLARK  
 Lieutenant General, USA  
 Commanding

~~SECRET // REL TO USA, FVEY~~



**//SECRET//REL TO USA FVEY**  
**DEPARTMENT OF THE ARMY**  
**1ST THEATER SUSTAINMENT COMMAND**  
**OPERATIONAL COMMAND POST**  
**CAMP ARIFJAN, KUWAIT**  
**APO AE 09366**

ACTS-SCK-DC

21 October 2021

MEMORANDUM FOR, LTG Ronald Clark, 3d Army/ United States Army Central, 1 Gabreski Dr., Shaw Air Force Base, South Carolina 29152

SUBJECT: Chronology for Investigation: Factual Summary of attack on U.S. Forces at Hamid Karzai International Airport (HKIA).

DATE (2021)	ACTIVITY	Location
16 Sep (1655L)	Legal advisor verbally informs Investigating Officer ("IO") of the investigation and provides CENTCOM Order	(b)(1)1.4a
16 Sep (1850L)	Legal advisor meets with IO and discusses the scope of the investigation and impending appointment order from US ARCENT. Assistant IOs are discussed and an assistant IO is identified and read in (b)(3)130b, (b)(6) Command Judge Advocate, 3d ESC)	
16 Sep (1945 – 2200)	Legal advisor and Asst IO develop initial investigation plan and identify units/points of contact to coordinate to obtain materials	
17 Sep (0057L)	US ARCENT coordinates with MARCENT SJA to have USMC subject matter expert on the investigative team.	
17 Sep (1733 – 1808L)	Legal advisor receives the US ARCENT appointment orders and provides copies to all identified IOs.	
17 Sep (1808 – 2000L)	Legal advisor and assistant IO develop draft investigative plan (5 initial chapters with multiple subparts)	
17 Sep	(b)(3)130b, (b)(6) (USMC) formally appointed as assistant IO	
18 Sep (1900-2000L)	Legal Advisor emails ARCENT SJA requesting additional IOs and giving status update	
18 Sept (2000-2100L)	Asst IO, (b)(3)130b, (b)(6) assigned, makes group communication page.	
20 Sep (0700-0800)	Draft Timeline for Investigation produced based on initial witness location. Intratheater travel coordinated.	

ACTS-DC

SUBJECT: Chronology for Investigation: Factual Summary of attack on U.S. Forces at Hamid Karzai International Airport (HKIA).

20 Sep (1040L)	Legal advisor notifies ARCENT OSJA about additional IO (b)(3)130b, (b)(6) and sends email on extension request	<p>(b)(1)1.4a</p>
21 Sep (1500-1630)	MARCENT appoints (b)(3)130b, (b)(6) as Asst IO and forwards to ARCENT	
22 Sep	USFOR-A FWD (b)(6) Interview	
22 Sep	TF MED (b)(3)130b, (b)(6) Interview	
23 Sep	Travel to Naval Support Activity (NSA) Bahrain	
24 Sep	JTF-CR (b)(6) Interview	
24 Sep	JTF-CR (b)(6)	
24 Sep	JTF-CR (b)(6) Interview	
24 Sep	JTF-CR CG Interview	
24 Sep	JTF-CR (b)(3)130b, (b)(6) Interview	
25 Sep	Consolidation of all photographs and products received from JTF-CR.	
25 Sep	Travel to (b)(1)1.4a	
26 Sep	Transcripts completed. Coordinated with future locations for lodging, vehicles, and work spaces. Begin work on findings and enclosures.	
27 Sep	USFOR-A FWD (b)(3)130b, (b)(6) Interview	
27 Sep	USFOR-A FWD (b)(3)130b, (b)(6) Interview	
28 Sep	USFOR-A FWD Embassy (b)(3)130b, (b)(6)	
28 Sep	USFOR-A FWD (b)(6)	
28 Sep	Collection of all enclosures and products from USFOR-A FWD.	
29 Sep	Travel to (b)(1)1.4a	
29 Sep	Acquired lodging and workspaces. Established communications and finished transcriptions from (b)(1)1.4a. Continue to develop findings and enclosures.	
30 Sep	2/1 Battalion (b)(3)130b, (b)(6) Interview	
30 Sep	2/1 Battalion (b)(3)130b, (b)(6) Interview	
30 Sep	2/1 BN (b)(3)130b, (b)(6) Interview	
30 Sep	2/1 E Co (b)(3)130b, (b)(6) Interview	
30 Sep	2/1 E Co (b)(3)130b, (b)(6) Interview	
30 Sep	2/1 E Co 4th Platoon (b)(3)130b, (b)(6) Interview	
01 Oct	2/1 E Co Platoon (b)(3)130b, (b)(6) Group Interview	
01 Oct	2/1 E Co Platoon (b)(3)130b, (b)(6) Group Interview	
01 Oct	2/1 E Co Squad (b)(3)130b, (b)(6) Group Interview	
01 Oct	2/1 (b)(6) Group Interview	
01 Oct	2/1 E Co (b)(6) Group Interview	

ACTS-DC

SUBJECT: Chronology for Investigation: Factual Summary of attack on U.S. Forces at Hamid Karzai International Airport (HKIA).

01 Oct	2/1 E Co (b)(3)130b, (b)(6)	(b)(1)1.4a
01 Oct	SPMAGTF (b)(6) Interview	
01 Oct	2/1 (b)(3)130b, (b)(6) Interview	
02 Oct	Collection of all enclosures and products received from 2/1 at (b)(1)1.4a	
02 Oct	Travel to (b)(1)1.4a	
03 Oct	Completion of transcripts from 2/1. (b)(3)130b, (b)(6) and (b)(3)130b, (b)(6) physically join the investigative team. Continue to develop findings and enclosures.	
03 Oct	Mortuary Affairs Team Interview	
03 Oct	Travel to Camp Pendleton, California	Camp Pendleton California
04 Oct	Travel to Camp Pendleton, California	Camp Pendleton California
05 Oct	Establish work space and communications. Finalize interview schedule with 2/1 at Camp Pendleton. Continue to develop findings and enclosures.	Camp Pendleton California
06 Oct	2/1 (b)(6) group Interview	Camp Pendleton California
06 Oct	2/1 G Co (b)(3)130b, (b)(6) Interview Part 1	Camp Pendleton California
06 Oct	2/1 F Co (b)(3)130b, (b)(6) Interview	Camp Pendleton California
06 Oct	2/1 Fox (b)(3)130b Interview	Camp Pendleton California
06 Oct	2/1 E Co Interview	Camp Pendleton California
07 Oct	2/1 G Co (b)(3)130b, (b)(6) Interview	Camp Pendleton California
07 Oct	2/1 G Co (b)(3)130b, (b)(6) group Interview	Camp Pendleton California
07 Oct	2/1 G Co Platoon (b)(3)130b, (b)(6) Group Interview	Camp Pendleton California
07 Oct	2/1 G Co Platoon (b)(3)130b, (b)(6) group Interview	Camp Pendleton California
07 Oct	2/1 G Co (b)(3)130b, (b)(6) Group Interview	Camp Pendleton California
07 Oct	2/1 G Co (b)(3)130b, (b)(6) Group Interview	Camp Pendleton California

ACTS-DC

SUBJECT: Chronology for Investigation: Factual Summary of attack on U.S. Forces at Hamid Karzai International Airport (HKIA).

07 Oct	2/1 G Co Marines, (b)(3)130b, (b)(6) Group Interview	Camp Pendleton California
07 Oct	2/1 G Co (b)(3)130b, (b)(6) Interview	Camp Pendleton California
07 Oct	2/1 G Co (b)(6) Group Interview	Camp Pendleton California
08 Oct	2/1 G Co (b)(3)130b, (b)(6) Interview Part 2	Camp Pendleton California
08 Oct	2/1 G Company (b)(3)130b, (b)(6) Group Interview	Camp Pendleton California
08 Oct	2/1 (b)(3)130b, (b)(6) Interview	Camp Pendleton California
08 Oct	2/1 G Co (b)(6)	Camp Pendleton California
08 Oct	Collection of all enclosures and products received from 2/1 at Camp Pendleton.	Camp Pendleton California
09 Oct	Travel to Fort Bragg, North Carolina	Fort Bragg, North Carolina
10 Oct	Work on transcripts from Camp Pendleton. Continue to develop findings and enclosures.	Fort Bragg, North Carolina
11 Oct	Work on transcripts from Camp Pendleton. Continue to develop findings and enclosures.	Fort Bragg, North Carolina
11 Oct	Travel to Camp Lejeune, North Carolina	Camp Lejeune, North Carolina
12 Oct	MEU (b)(3)130b, (b)(6) Interview	Camp Lejeune, North Carolina
12 Oct	CLB (b)(3)130b, (b)(6) Interview	Camp Lejeune, North Carolina
12 Oct	(b)(6) Interview	Camp Lejeune, North Carolina
12 Oct	BLT 1-8, (b)(3)130b, (b)(6) Interview	Camp Lejeune, North Carolina
13 Oct	1/8 (b)(3)130b, (b)(6) Interview	Camp Lejeune, North Carolina
13 Oct	MEU (b)(6) Interview	Camp Lejeune, North Carolina
13 Oct	MEU (b)(3)130b, (b)(6) Interview	Camp Lejeune, North Carolina
13 Oct	MEU (b)(6) Interview	Camp Lejeune, North Carolina
13 Oct	MEU (b)(3)130b, (b)(6) Interview	Camp Lejeune, North Carolina



ACTS-DC

SUBJECT: Chronology for Investigation: Factual Summary of attack on U.S. Forces at Hamid Karzai International Airport (HKIA).

13 Oct	MEU (b)(3)130b, (b)(6) Interview	Camp Lejeune, North Carolina
14 Oct	Progress brief to LTG Clark	Camp Lejeune, North Carolina
14 Oct	Collection of all enclosures and products received from the MEU. Work on transcripts from Camp Lejeune. Continue to develop findings and enclosures.	Camp Lejeune, North Carolina
15 Oct	1/82 IBCT (b)(3)130b, (b)(6) Interview	Fort Bragg, North Carolina
15 Oct	2/501 (b)(3)130b, (b)(6) Interview	Fort Bragg, North Carolina
15 Oct	B Co (b)(3)130b, (b)(6) Interview	Fort Bragg, North Carolina
15 Oct	82nd Airborne Div (b)(3)130b, (b)(6) Interview	Fort Bragg, North Carolina
18 Oct	3 BDE (b)(3)130b, (b)(6) Interview	Fort Bragg, North Carolina (SVTC)
18 Oct	(b)(3)130b, (b)(6) Interview	Fort Bragg, North Carolina (SVTC)
18 Oct	(b)(3)130b, (b)(6) USFOR-A Interview	Fort Bragg, North Carolina (SVOIP)
18 Oct	(b)(3)130b, (b)(6) Interview	Fort Bragg, North Carolina
18 Oct	(b)(3)130b, (b)(6) 82nd ABN DIV Interview	Fort Bragg, North Carolina
18 Oct	82nd Airborne (b)(3)130b, (b)(6) Interview	Fort Bragg, North Carolina
19 Oct	TF Med (b)(3)130b, (b)(6) Interview	Fort Bragg, North Carolina (SVOIP)
19 Oct	(b)(6) Interview	Fort Bragg, North Carolina (DSN)
19 Oct	USEMB Kabul Consular General Interview	Fort Bragg, North Carolina (SVTC)
19 Oct	82nd Airborne (b)(3)130b, (b)(6) Interview	Fort Bragg, North Carolina
19 Oct	Collection of all enclosures and products received at Fort Bragg. Complete all transcripts. Develop findings and enclosures.	Fort Bragg, North Carolina

ACTS-DC

SUBJECT: Chronology for Investigation: Factual Summary of attack on U.S. Forces at Hamid Karzai International Airport (HKIA).

20 Oct	Rough Draft of findings complete. Review, edit, and prepare for submission.	Fort Bragg, North Carolina
21 Oct	Review, edit, and prepare for submission.	Fort Bragg, North Carolina
22 Oct	Review, edit, and prepare for submission.	Fort Bragg, North Carolina
22 Oct	Investigation submitted to ARCENT.	Fort Bragg, North Carolina

2. The point of contact is [redacted] (b)(3)130b, (b)(6) at DSN: [redacted] (b)(6) or email: [redacted] (b)(3)130b, (b)(6)

LANCE G. CURTIS  
Brigadier General, USA  
Investigating Officer



~~SECRET//REL USA FVEY~~

DEPARTMENT OF THE ARMY  
3RD EXPEDITIONARY SUSTAINMENT COMMAND  
CAMP ARIFJAN, KUWAIT  
APO, AE 09366

ACTS-SCK-DO

22 October 2021

MEMORANDUM FOR RECORD

SUBJECT: Terms of Reference for Findings and Recommendation – Attack Against U.S. Forces Conducting NEO at Hamid Karzai International Airport on 26 August 2021

1. The purpose of this memorandum is to consolidate the Terms of Reference for acronyms used in the Findings and Recommendation – Attack Against U.S. Forces Conducting NEO at Hamid Karzai International Airport on 26 August 2021.
2. The Terms of Reference as used in the Findings and Recommendation are as follows:

Term	Definition
1/8	1st Battalion, 8th Marine Regiment
2/1	2nd Battalion, 1st Marine Regiment
2 PARA	2nd Battalion, Parachute Regiment (UK)
3/10	3rd Brigade, 10th Mountain Division
AELT	Aeromedical Evacuation Liaison Team
AMCIT	American Citizen
ANDSF	Afghan National Defense and Security Forces
AOR	Area of Responsibility
APOD	Aerial Port of Debarkation
APOE	Aerial Port of Embarkation
BEC	Baghdad Embassy Compound
BLT	Battalion Landing Team
CASEVAC	Casualty Evacuation
CCP	Casualty Collection Point
CE	Command Element
CENTCOM	United States Central Command
CLB	Combat Logistics Battalion
CLD	Combat Logistics Detachment
COCOM	Combatant Command
COMREL	Command Relationship
CONUS	Continental United States
CT	Computed Tomography (Scan)
DAP	Diplomatic Assurance Platform
DoS	Department of State
DRE	Deployment Readiness Exercise
ECP	Entry Control Point

~~SECRET//REL USA FVEY~~

SUBJECT: Terms of Reference for Findings and Recommendation – Attack Against U.S. Forces Conducting NEO at Hamid Karzai International Airport on 26 August 2021

EOD	Explosive Ordnance Disposal
ER	Emergency Room
FLA	Field Litter Ambulance
FRSD	Forward Resuscitative Surgical Detachment
FRST	Forward Resuscitative Surgical Team
GCE	Ground Combat Element
HKIA	Hamid Karzai International Airport
HQ	Headquarters
IAW	In accordance with
IBCT	Infantry Brigade Combat Team
ICC	International Coordination Cell
ICU	Intensive Care Unit
IED	Improvised Explosive Device
IIT	Infantry Immersion Trainer
JOC	Joint Operations Center
JRTC	Joint Readiness Training Center
JS	Joint Staff
JSOTF-A	Joint Special Operations Task Force-Afghanistan
JTE	Joint Tactical Exfiltration
JTF	Joint Task Force
JTF-CR	Joint Task Force-Crisis Response
KIA	Killed in Action
LNO	Liaison Officer
LPD	Leader Professional Development
LPR	Lawful Permanent Resident
MARCENT	Marine Corps Forces Central Command
MASCAL	Mass Casualty
MEB	Marine Expeditionary Brigade
MEDROE	Medical Rules of Engagement
MET	Mission Essential Task
MEU	Marine Expeditionary Unit
MFR	Memorandum for Record
MNCC	Multi-National Coordination Cell
MTF	Military Treatment Facility
MWSD	Marine Wing Support Detachment
NCO	Noncommissioned Officer
NEO	Noncombatant Evacuation Operations
NSOCC-A	NATO Special Operations Component Command-Afghanistan
NSU	National Strike Unit
OGA	Other Governmental Agency

SUBJECT: Terms of Reference for Findings and Recommendation – Attack Against U.S. Forces Conducting NEO at Hamid Karzai International Airport on 26 August 2021

OPT	Operation Planning Team
OR	Operating Room
PDSS	Pre-Deployment Site Survey
PIR	Parachute Infantry Regiment
PJ	Air Force Pararescue
RIP	Relief in Place
ROC	Rehearsal of Concept
ROE	Rules of Engagement
Role I-E	Role I Enhanced
SIV	Special Immigrant Visa
SOST	Special Operations Surgical Team
SPMAGTF	Special Purpose Marine Air Ground Task Force
SVIED	Suicide Vest Improvised Explosive Device
TAC	Tactical Command Post
TBI	Traumatic Brain Injury
TF	Task Force
TF MED	Task Force Medical
TOA	Transfer of Authority
TTX	Table Top Exercise
USFOR-A FWD	U.S. Forces-Afghanistan Forward
VBIED	Vehicle-Borne Improvised Explosive Device
XO	Executive Officer

5. The point of contact for this memorandum is the undersigned at [redacted (b)(6)] and

[redacted (b)(3)130b, (b)(6)]

[redacted (b)(3)130b, (b)(6)]

**Enclosure 6 – Exhibit List**

1. JTF-CR After Action Review Presentation, 17 SEP 2021
2. JTF-CR After Action Review Planning and Execution Timeline, 17 SEP 2021
3. JTF-CR Retrograde Plan, 26 AUG 2021
4. JTF-CR Surgeon Cell MEDCOP, 27 AUG 2021
5. SPMAGTF-CR-CC EOD Blast Analysis, 26-27 AUG 2021
6. 2/1 Marines Task Organization
7. USCENTCOM FRAGO 31-002 to OPORD 31 MOD 001 (Joint Forcible Entry), 16 AUG 2021
8. USCENTCOM Noncombatant Evacuation Operations Withdrawal Plan, 21 AUG 2021
9. USCENTCOM FRAGO 31-003 to OPORD 31 MOD 001 (Withdraw), 20 AUG 2021
10. USCENTCOM Task Organization, No Date (v6.3)
11. USCENTCOM Commander Email, Task Organization, 17 AUG 2021
12. XVIII ABC Outload Brief, 17 AUG 2021
13. MFR, USFOR-A FWD J2, J3, SJA Interview, 22 SEP 2021
14. MFR, TF MED (b)(6) Interview, 22 SEP 2021
15. MFR, JTF-CR (b)(6) Interview, 23 SEP 2021
16. MFR, JTF-CR (b)(6) 24 SEP 2021
17. MFR, JTF-CR (b)(6) Interview, 24 SEP 2021
18. MFR, JTF-CR (b)(6) Interview, 24 SEP 2021
19. MFR, JTF-CR (b)(6) Interview, 24 SEP 2021
20. MFR, USFOR-A FWD (b)(6) Interview, 27 SEP 2021
21. MFR, USFOR-A FWD (b)(6) Interview, 27 SEP 2021
22. MFR, USFOR-A FWD Embassy (b)(6) Interview, 28 SEP 2021
23. MFR, USFOR-A FWD (b)(6) Interview, 28 SEP 2021
24. USFOR-A FWD Timeline of Key Events
25. USFOR-A FWD HKIA Security Assessment, 29 JUL 2021
26. USFOR-A FWD Abbey Gate Attack and Blast Site (3 Slides)
27. USFOR-A FWD HKIA SITEMP
28. USFOR-A FWD North Gate Traffic Circle Taliban Engagement of Motor Vehicle
29. USFOR-A FWD EXSUM of 26 AUG 21 Attack on HKIA (Abbey Gate)
30. USFOR-A FWD Decision Points Matrix, 14 AUG 2021
31. USFOR-A FWD HKIA Initial Security Assessment, 27 JUL 2021
32. USFOR-A FWD HKIA Security Assessment, 28 JUL 2021
33. JTF-CR Forces and Planning Overview, 23 JUL 2021
34. (b)(1)1.4a Planning Order for Support to NEO, 17 JUN 2021
35. (b)(1)1.4a NEO OPORD, 14 JUL 2021
36. (b)(1)1.4a FRAGO 1 to NEO OPORD, Plan for Execution, 17 JUL 2021
37. (b)(1)1.4a FRAGO 2 to NEO OPORD, Plan for Execution, 17 JUL 2021
38. (b)(1)1.4a FRAGO 3 to NEO OPORD, Plan for Execution, 17 JUL 2021
39. JTF-CR J3 Force Flow and COMREL Notes (handwritten), 12 AUG 2021
40. USFOR-A FWD FRAGO 11
41. JTF-CR Planning Timeline, 17 SEP 2021
42. JTF-CR Commander's Placemat, 23 AUG 2021
43. JTF-CR Commander's Placemat, 25 AUG 2021

44. USFOR-A FWD PERSTAT as of 23 AUG 2021
45. JTF-CR Force Generation Timeline, 12 AUG 2021
46. USCENTCOM EXORD, Support to NEO, 13 Aug
47. JTF-CR Retrograde Timeline, 26 AUG 2021
48. Memorandum of Agreement, DoS and DoD, DoD Support to RSO Security Operations
49. Medical Services Annex (Q), USCENTCOM OPLAN 1710-18, 30 MAR 18
50. JTF-CR Casualty Notification/Coordination, 15 AUG 21
51. JTF-CR MEDSITREP and COP, 22 AUG 2021
52. USCENTCOM MEDROE, App. 7 to Annex Q to OPOD 25, 7 FEB 17
53. MFR, 2/1 Battalion (b)(6) Interview 30 SEP 21
54. MFR, 2/1, Battalion (b)(6) Interview 30 SEP 21
55. MFR, 2/1 BN (b)(6) Interview 30 SEP 21
56. MFR, 2/1 E Co (b)(6) Interview 30 SEP 21
57. MFR, 2/1 E Co (b)(6) Interview 30 SEP 21
58. MFR, 2/1 E Co 4th Platoon (b)(6) Interview 7 OCT 21
59. MFR, 2/1 E Co Platoon (b)(6) Group Interview 1 OCT 21
60. MFR, 2/1 E Co Platoon (b)(6) Group Interview 1 OCT 21
61. MFR, 2/1 E Co (b)(6) group Interview 1 OCT 21
62. MFR, 2/1 (b)(6) group Interview 1 OCT 21
63. MFR, 2/1 E Co (b)(6) Group Interview 1 OCT 21
64. MFR, 2/1 E Co, First Platoon (b)(6) Interview 1 OCT 21
65. MFR, (b)(6) TL Interview 1 OCT 21
66. MFR, (b)(6) Interview 6 OCT 21
67. MFR, (b)(6) team interview 3 OCT 21
68. HKIA MASCAL AE-CCATT
69. USFOR-A FWD Taliban Takeover Progression
70. USFOR-A FWD Micro Timeline of Abbey Gate Attack
71. USFOR-A FWD MFR, EXECSUM to Final AAR, 17 SEP 21
72. AFGHAN NEO (b)(1)1.4c saying 1736 High explosive (b)(1)1.4c
73. CENTCOM Abbey Gate Bullets NARRATIVE
74. USFOR-A FWD HKIA/NEO AAR to CENTCOM, 24 SEP 21
75. Abbey Gate Crowd Imagery, AUG 21
76. MFR, 2/1 (b)(6) group Interview 6 OCT 21
77. MFR, 2/1 (b)(6) Interviews 6 and 8 OCT 21
78. MFR, 2/1 (b)(6) Interview 7 OCT 21
79. MFR, 2/1 (b)(6) Interview 6 OCT 21
80. MFR, 2/1 (b)(6) group Interview 7 OCT 21
81. MFR, 2/1 (b)(6) Interview 6 OCT 21
82. MFR, 2/1 (b)(6) Interview 6 OCT 21
83. MFR, 2/1 (b)(6) Group Interview 7 OCT 21
84. MFR, 2/1 (b)(6) group Interview 7 OCT 21
85. MFR, 2/1 (b)(6) Group Interview 7 OCT 21
86. MFR, 2/1 (b)(6) Group Interview 7 OCT 21
87. MFR, 2/1 (b)(6) Group Interview, 7 OCT 21
88. MFR, 2/1 (b)(6) Group Interview 8 OCT 21

89. MFR, 2/1 (b)(6) Interview 7 OCT 21
90. MFR, 2/1 (b)(6) Interview 8 OCT 21
91. MFR, G Co, 2/1 Marines, Marines KIA Sketch and Discussion, 7 OCT 21
92. MFR, G Co, 2/1 Marines, (b)(6) KIA and WIA Sketch and Discussion, 8 OCT 21
93. MFR, E Co, 2/1 Marines, (b)(6) 26 AUG Gate Sketch and Discussion, 1 OCT 21
94. MFR, 2/1 Marines, (b)(6) 26 AUG Gate Sketch and Discussion, 1 OCT 21
95. 2/1 Marines, (b)(6) Post-Attack Analysis, 15 SEP 21
96. MFR, USFOR-A (b)(6) Interview, 22 OCT 21
97. (b)(6) NEO Placemats, 26 and 27 AUG 21
98. MFR, 2/1 (b)(6) Group Interview, 7 OCT 21
99. MFR, 2/1 (b)(6) Interview, 8 OCT 21
100. MFR, (b)(6) Interview, 12 OCT 2021
101. MFR, (b)(6) Interview, 12 OCT 2021
102. MFR, (b)(6) Interview, 12 OCT 2021
103. MFR, (b)(6) Interview, 12 OCT 2021
104. MFR, (b)(6) Interview, 13 OCT 2021
105. MFR, (b)(6) Interview, 13 OCT 2021
106. MFR, (b)(6) Interview, 13 OCT 2021
107. MFR, (b)(6) Interview, 13 OCT 2021
108. MFR, (b)(6) Interview, 13 OCT 2021
109. Dept of State EXSEC Request Dept of Defense for NEO Support, 16 Aug
110. (b)(3)130b; (b)(6) Sworn Statement, 24 MEU, 26 Aug
111. (b)(3)130b; (b)(6) Sworn Statement, 24 MEU, 26 Aug
112. USMARCENT Afghanistan NEO AAR
113. USMARCENT Afghanistan NEO AAR EXSUM
114. USARCENT After Action Review of NEO at HKIA
115. USFOR-A (b)(1)1.4c Log
116. USCENTCOM OPORD 31
117. USCENTCOM MOD 1 to OPORD 31
118. USCENTCOM APPENDIX 7 to ANNEX C MODIFICATION 006 TO OPORD 25
119. CJCSI 3121.01B Standing Rules of Engagement
120. USCENTCOM MODIFICATION 006 TO OPORD 25
121. MFR, 1/82 (b)(6) Interview, 15 OCT 21
122. MFR, (b)(6) Interview, 13 OCT 21
123. MFR, (b)(6) Interview, 15 OCT 21
124. MFR, B Co (b)(6) Interview, 15 OCT 21
125. MFR, 82nd Airborne (b)(6) Interview, 15 OCT 21
126. MFR, 3/10 (b)(6) Interview, 18 OCT 21
127. MFR, (b)(6) Interview, 18 OCT 21
128. MFR, (b)(6) USFOR-A Interview, 18 OCT 21
129. MFR, (b)(6) Interview, 18 OCT 21
130. MFR, (b)(6) 82nd ABN DIV Interview, 18 OCT 21
131. MFR, (b)(6) Interview, 18 OCT 21
132. 2/1 (b)(6) NEO after action MSE (b)(6)
133. ABBEY GATE Imagery 2/1 (b)(6)



134. Abbey Gate Post Blast
135. USCENTCOM [REDACTED] (b)(1)1.4c
136. 2/1 Marines Consolidated Debrief Document (no date)
137. Force Laydown and Overview of 26 AUG SBIED from 2/1 [REDACTED] (b)(6)
138. JTAPIC Incident 200000015 - PBIED - 26 AUG 21
139. NGIC CIAD\_26AUG21 PBIED HKIA Attack
140. TB Casualties\_210827004269
141. HKIA 1BCT Timeline Intel Extract
142. USFORAJ2 Chat Logs 20210815-20210831
143. HKIA Timeline Sync Matrix V.2
144. MFR, [REDACTED] (b)(6) Interview, 17 OCT 21
145. MFR, Autopsy Summary, 19 OCT 21
146. MFR, [REDACTED] (b)(6) Interview, 19 OCT 21
147. MFR, 82nd Airborne CSM Interview, 19 OCT 21
148. UK Analysis of Abbey gate Incident, 18 OCT 21
149. MFR - 82nd Airborne [REDACTED] (b)(6) Interview 18 OCT 21
150. JTF-CR JPERSTAT 20210820
151. JTF-CR JPERSTAT 20210826
152. 82ABD FWD BUA 240727AUG21
153. 82ABD FWD BUA 260700AUG21
154. 82ABD FWD BUA 270700AUG21
155. 82nd Operations Overlay Placemat, 23 AUG 21
156. SITREP- 230700AUG-241900AUG
157. SITREP- 241900AUG-250700AUG
158. SITREP- 250700AUG-261900AUG
159. SITREP- 251900AUG-260700AUG
160. SITREP- 261900AUG-270700AUG
161. SITREP- 270700AUG-271900AUG
162. SITREP- 271900AUG-280700AUG
163. MARCENT Abbey Gate KIA Roster, 13 OCT 21
164. MARCENT Abbey Gate WIA Roster, 13 OCT 21
165. Open Source, SVIED, CNN, 6 OCT 21
166. MFR, JTF82 HKIA EXSUM, 08 OCT 21
167. PICTURE 19 AUG Cleared Outer Corridor area
168. PICTURE 19 AUG Shortly after arriving
169. PICTURE 20 AUG Morning after Brits
170. PICTURE 20 AUG Very little control at Chevron
171. PICTURE 21 AUG 30m Outside Gate
172. PICTURE 21 AUG 1630 Don't Have Control Of Canal
173. PICTURE 21 AUG Canal at Night
174. PICTURE 22 AUG 0530 Sleep Between Inner and Outer
175. PICTURE 22 AUG 1500 Control Near Side Of Canal
176. PICTURE 24 AUG Sniper Tower pic 1
177. PICTURE 24 AUG Sniper Tower pic 2
178. PICTURE 24 AUG Sniper Tower pic 3
179. PICTURE 24 AUG 2 PARA Withdraw Plan

180. PICTURE 26 AUG 0830 Crowd More Desperate
181. PICTURE 26 AUG 0900 Jersey Barrier
182. PICTURE 26 AUG 0930 Reinforced Jersey Barrier
183. PICTURE 26 AUG 1757 Panoramic
184. PICTURE 26 AUG Identified Man Shortly Before Attack
185. PICTURE 26 AUG Jersey barrier And Sniper Blast Perspective
186. PICTURE Abbey Gate Between Inner and Outer Gate
187. PICTURE Abbey Gate Canal At Night
188. PICTURE Abbey Gate Sat Picture
189. PICTURE 26 AUG Jersey barrier And Sniper Blast Perspective 2
190. PICTURE Abbey Gate Sat Picture Connex Zoom
191. PICTURE Abbey Gate Sat Picture Sniper
192. PICTURE Abbey Gate View On Wall Looking To Chevron
193. PICTURE Airfield getting overrun
194. PICTURE Man identified by Recon as suspect accomplice
195. PICTURE Inside Sniper Tower
196. PICTURE ROE Cards handed to Marines
197. PICTURE Security Between East and Abbey
198. PICTURE East Gate Crowd
199. PICTURE East Gate Day Marines On Line
200. PICTURE East Gate Crowd Left Side Connex
201. PICTURE East Gate Crowd Right Side Zoom
202. PICTURE East Gate Night Marines On Left Side Guard
203. PICTURE North Gate Marines Holding Crowd
204. PICTURE North Gate Marines On Line
205. VIDEO 19 AUG 0857 Brits Controlled Outer Gate
206. VIDEO 22 AUG 0645 Outer Gate Acceptance Lane
207. VIDEO 22 AUG 0700 360 View
208. VIDEO 25 AUG 0930 Drive To Abbey Gate
209. VIDEO 25 AUG North Past Sniper Tower
210. VIDEO 26 AUG 0900 View From Canal Jersey Barrier South
211. VIDEO 26 AUG Graphic After Blast Far Edge
212. VIDEO 26 AUG Graphic After Blast Near Side below sniper
213. VIDEO 26 AUG (b)(3)130b; (b)(6) Close Shows Canal
214. VIDEO 26 AUG 360 About 5 minutes Before Blast Brit Video, UK Certification
215. VIDEO 26 AUG Abbey Gate 30m From Sniper Tower North
216. VIDEO Blast Footage 2 sec
217. VIDEO 26 AUG Abbey Gate Blast Site Canal View Back Towards Jersey Barrier
218. VIDEO Abbey Gate Crowd and Chevron
219. VIDEO 26 AUG Abbey Gate Jersey Barrier Crowd Situation
220. VIDEO Abbey Gate Marine Gets Pulled Into Crowd
221. VIDEO Abbey Gate On Jersey Barrier With Crowd
222. VIDEO Abbey Gate South Canal Through Hole In Gate
223. VIDEO UAV Footage From (b)(1)1.4a after blast and Time Stamp
224. PSYOPS NCO Sketch by location
225. Text for picture context 1

226. Text for picture context 2
227. Text for picture context 3
228. Text for picture context 4
229. Text for picture context 5
230. Text for picture context 6
231. Text for picture context 7
232. Text for picture context 8
233. Text for picture context 9
234. Text for picture context 10
235. Text for picture context 11
236. HKIA, (b)(1)1.4c 261736AUG21
237. MFR, (b)(6) 24 MEU, Follow up Interview, 27 Oct 21
238. USCENTCOM J3 Night Order 17 AUG 21
239. USCENTCOM J3 Night Order 31 AUG 21
240. USCENTCOM J3 Night Order 8 SEP 21
241. USCENTCOM FRAGO 01 to OPORD 31, 15 JUL 21 (Early Assistance Team)
242. USCENTCOM FRAGO 04 to OPORD 31, 21 AUG 21 (b)(1)1.4a
243. USCENTCOM FRAGO 04 to OPORD 31, 23 AUG 21 (Retrograde)
244. USCENTCOM FRAGO 05 to OPORD 31, 23 AUG 21 (JTE)
245. USCENTCOM FRAGO 001 to OPORD 25 (MOD 5), 12 MAY 21 (JTF-CR Activation)
246. (b)(1)1.4c 82nd Final Departure from HKIA, 31 AUG 21
247. MFR, (b)(6) Follow Up Interview, 29 OCT 21
248. DD Form 2064, Certificate of Death, SSG Ryan Knauss, 26 AUG 21
249. JTF-CR J3 Task Organization/COMREL Layout, 23 SEP 21
250. MFR, ISIS-K Video Acquisition, 29 OCT 21
251. Open Source, New York Times, US Troops Searched Afghans, a bomber in the Crowd Moves in, 27 AUG 21
252. Open Source, New Your Magazine, Biden Vows Retribution for Kabul Attack That Killed 13 Americans, 27 AUG 21
253. 24th MEU ROE Card (no date)
254. Preliminary Findings of Post Suicide Vest Attack on Coalition Forces at Abbey Gate, HKIA, 28 AUG 21 (with 5 attachments – 1-5)
255. Forensic Exploitation Laboratory Results (Post-Analysis), 2 SEP 21
256. Joint Theater Forensic Analysis Center Exploitation Summary, 2 SEP 21
257. Open Source Photo from Outer Gate to Barron Hotel
258. Open Source Photo from Gate Canal View
259. Open Source Photo Bypassing Taliban



~~SECRET//REL USA FVEY~~

**DEPARTMENT OF THE ARMY**  
**3RD EXPEDITIONARY SUSTAINMENT COMMAND**  
**CAMP ARIFJAN, KUWAIT**  
**APO, AE 09366**

ACTS-SCK-DO

22 October 2021

MEMORANDUM FOR LTG Ronald P. Clark, Commander, Third Army/U.S. Army Central, Shaw Air Force Base, SC

SUBJECT: Enclosure 7 – Executive Summary for Findings and Recommendations – Attack Against U.S. Forces Conducting Non-combatant Evacuation Operations (NEO) at Hamid Karzai International Airport (HKIA) on 26 August 2021

1. **Purpose:** This memorandum serves as the executive summary of the findings and recommendations for the investigation into the attack against U.S. Forces conducting NEO at Hamid Karzai International Airport on 26 August 2021.

2. **Findings.**

a. **Task Organization.**

(1) U.S. Central Command (CENTCOM) designated the United States Forces Afghanistan Forward (USFOR-A FWD), commanded by RADM Peter Vasely, as the overall military command for NEO in support of the U.S. Embassy, Kabul. Beginning with its activation in May 2021, Joint Task Force-Crisis Response (JTF-CR), commanded by BGen Farrell Sullivan, was under tactical control (TACON) of USFOR-A FWD for NEO planning, and eventually for NEO execution in August 2021. All forces at HKIA were subordinate to JTF-CR for execution of NEO activities until 17 August. On 18 August, Gen McKenzie published an adjusted task organization accounting for the arrival of the 82nd Airborne Division Tactical Command Post (TAC), Commanded by MG Christopher Donahue, with 1/82 Infantry Brigade Combat Team (IBCT) as a subordinate unit within his Command. This adjusted task organization made all Marine forces TACON to the JTF-CR. 2/1 Marines, from CENTCOM's Special Purpose Marine Air Ground Task Force (SPMAGTF), would be further TACON to the 24th Marine Expeditionary Unit (MEU). JTF-CR was TACON to the 82nd Airborne Division TAC, and the 82nd Airborne Division was TACON to USFOR-A FWD (see embedded task organization diagram).

(2) Leaders on the ground adjusted the task organization. 2/1 Marines maintained a direct reporting relationship with the JTF-CR and a limited TACON relationship with 24th MEU. The JTF-CR was TACON to the USFOR-A FWD Commander for executing NEO and only coordinated with the 82nd Airborne Division TAC.

~~SECRET//REL USA FVEY~~

ACTS-SCK-DO

SUBJECT: Enclosure 7 - Executive Summary for Findings and Recommendation – Attack Against U.S. Forces Conducting Non-combatant Evacuation Operations (NEO) at Hamid Karzai International Airport on 26 August 2021

**b. Key Facts.**

(1) From 14-17 August, elements of the 24th MEU, to include the Command Element (CE), the Battalion Landing Team (BLT), 1/8 Marines, and Combat Logistics Battalion (CLB) 24 arrived at HKIA. Simultaneously, 2/1 Marines of the SPMAGTF and the 1/82 IBCT arrived at HKIA. During the hours of darkness on 16 August, Afghan civilians rushed the airfield, forcing the limited combat power to focus on securing the runway to enable continued air operations. U.S. Forces, with assistance from Taliban and Afghan National Strike Unit (NSU) forces, secured the airfield by 17 August. Also on 17 August, 1/8 Marines opened East and North Gates to begin screening evacuees, and CLB-24 began Evacuation Control Center operations (ECC) to process and manifest evacuees for departure. On 19 August, 2/1 Marines opened Abbey Gate.

(2) The 82nd Airborne Division TAC arrived on 19 August, and assumed responsibility for airfield security, although the MEU retained responsibility for the perimeter in vicinity of North, East, and Abbey Gates and the East side of the airfield. 1/82 IBCT secured the North, West, and South sides of HKIA. JTF-CR retained responsibility for NEO, specifically ECC and gate operations in the MEU sector of HKIA.

(3) Operations at Abbey Gate began on 19 August with a daylight attempt to screen for eligible evacuees. The size and aggressiveness of the crowd overwhelmed Golf and Fox Company, 2/1 Marines so they shut the gate. In the period of darkness on 20 August, Golf Company, [REDACTED] (b)(3) 10 U.S.C. 130b, (b)(6) with Fox Company (-) in support, pushed the crowds back to the entrance road by the Barron Hotel. Engineer assets from 24th MEU emplaced shipping containers past the entrance road, establishing the "Chevron" obstacle south of Abbey Gate. Over the next several days, Echo Company, Golf Company, and Fox Company (-), 2/1 Marines established gate operations for crowd control, screening, searching, and movement through Abbey Gate. The layout of Abbey Gate allowed for standoff and control not present at other gates. The Chevron, controlled by the Taliban, was at the south end of Abbey Gate. The area between the Chevron and the outer gate was the outer corridor. 2/1 Marines conducted crowd control at the canal (generally running east/west), screening through the Chevron, and operating a holding area for potential evacuees in the vehicle lanes of the outer corridor. Two electronic countermeasure devices were employed in the outer corridor. There was a security tower at the outer gate, occupied by a sniper team, 2/1 Marines, who provided overwatch of gate operations. The area inside the outer gate, known as the inner corridor, was where Marines conducted searches, established a casualty collection point (CCP), and the Department of State (DoS) conducted document screening. The gate to the north of the inner corridor, closest to the airfield, was known as inner gate. The SPMAGTF Shock Trauma Platoon (STP), operating in direct support of 2/1 Marines, established their Role I facility between Abbey Gate and East Gate.

ACTS-SCK-DO

SUBJECT: Enclosure 7 - Executive Summary for Findings and Recommendation – Attack Against U.S. Forces Conducting Non-combatant Evacuation Operations (NEO) at Hamid Karzai International Airport on 26 August 2021

(4) From 19-25 August, Abbey Gate was open continuously for processing evacuees, with the exception of some pauses (20-22 August), due to a lack of capacity at intermediate staging bases throughout the AOR. East and North Gates proved untenable due to gate infrastructure, aggressiveness of crowds, and risk of attack to an exposed force, and both gates were closed by 25 August. During this period, U.K. Forces (specifically 2nd Battalion, Parachute Regiment (2 PARA)), were executing their own NEO from the Barron Hotel, south of Abbey Gate. Threat streams varied from vehicle borne improvised explosive devices (VBIED) and suicide vest (SVIED) attacks, to threats of evacuees detonating explosives aboard aircraft. The 82nd Airborne Division began planning the Joint Tactical Exfiltration (JTE), demilitarization of equipment, and retrograde of U.S. Forces and equipment. By 22 August, the 82nd Airborne Division was screening evacuees at South and West Gates.

(5) Threat reporting for 26 August warned of a potential SVIED against an HKIA gate, but specifics were similar to other threat streams. In response to the threat reporting, 2/1 Marines at Abbey Gate adjusted their force posture, similar to previous threats, consolidated medical personnel and equipment at their CCP within the inner corridor, and staged a STP Enroute Care Team near the inner gate. Crowds at Abbey Gate grew in size and desperation on 25 and 26 August. The gate was scheduled to close on 25 August, but U.K. Forces had not completed operations at the Barron Hotel. Closure timelines changed multiple times throughout 25-26 August. U.S. and U.K. leaders agreed to keep Abbey Gate open until the morning of 27 August, at which time U.K. Forces planned to complete their passage of friendly lines. With Abbey Gate's closure delayed, 2/1 Marines continued to screen potential evacuees on 26 August. The desperation and aggressiveness of the crowd forced Golf Company, 2/1 Marines to surge to the base of the sniper tower (near the outer gate) to ensure the large, unruly crowd did not breach the gate. At 1736 local time, a suicide bomber detonated a person borne improvised explosive device (PBIED) directly across from a large group of Marines posting security at the base of the sniper tower. The attack killed 13 Service Members, and initially wounded 27 others, resulting in the medical evacuation of 19 Service Members from HKIA.

(6) The Marines' reaction to the attack at Abbey Gate was professional. Immediately following the attack, Marines established security in vicinity of the outer gate, and some Marines reported receiving and returning fire. Service Members transported all casualties from the outer corridor to the CCP in the inner corridor within 15-20 minutes of the attack. All casualties were triaged and transported to the Role II-Enhanced (Role II-E) on North HKIA within an hour. After completion of the casualty evacuation, Echo Company, 2/1 assumed control of Abbey Gate and closed the outer gate, while U.K. and Taliban forces controlled the outer corridor. At 0500 on 27 August, Bravo Company, 2-501 Parachute Infantry Regiment (PIR) relieved Echo Company, 2/1

ACTS-SCK-DO

SUBJECT: Enclosure 7 - Executive Summary for Findings and Recommendation – Attack Against U.S. Forces Conducting Non-combatant Evacuation Operations (NEO) at Hamid Karzai International Airport on 26 August 2021

Marines. Upon concluding their operations at Barron Hotel at approximately 0700, U.K. Forces passed through Abbey Gate. On 29 August, 2/1 Marines departed HKIA for Kuwait and Saudi Arabia. The 82nd Airborne Division completed the JTE, demilitarization of equipment, and retrograde of U.S. Forces and equipment, and fully departed HKIA at 0002 local time on 31 August.

c. Key Findings.

(1) **The task organization worked. This was in large part due to pre-existing or quickly forged relationships among leaders at the highest echelons and adaptability at the lower echelons.** The Commanders of USFOR-A FWD, 82nd Airborne Division, and JTF-CR met daily to de-conflict and synchronize efforts to secure the airfield and process evacuees. The relationship developed between the USFOR-A FWD Commander and JTF-CR Commander during the NEO, and the prior relationship between the USFOR-A FWD Commander and the 82nd Airborne Division Commander, were key to ensuring a unity of effort to execute the NEO and JTE. The evidence clearly shows the exercise of engaged leadership to overcome the challenges presented by a dynamic environment and to evacuate as many at-risk Afghan civilians as possible.

(2) **By 25 August, Abbey Gate was the main effort for gate operations at HKIA.** The terrain and infrastructure at East and North Gates, coupled with threats to force and large, unruly crowds, made these gates untenable for evacuation operations. Both gates were effectively closed between 20-25 August. The West and South Gates were still operational and used for coordinated arrivals and openings. The decreased access to entry control points at HKIA forced DoS and Partner Nations to direct most small groups and individual evacuees to Abbey Gate. The structure of Abbey Gate provided some standoff from crowds due to the natural barrier created by the canal and a reduced VBIED threat because of the Chevron. The gate had effective overwatch positions and the Taliban were screening the main approach. Over time, crowds bypassed Taliban checkpoints to get to the canal and seek access to HKIA.

(3) **There was no complex attack; it was a single suicide bomber not accompanied by enemy small arms fire.** No U.S. or U.K. Forces reported a second explosion in vicinity of Abbey Gate. Although some Marines reported receiving fire, and several Marines returned fire, the evidence does not support the Marines were engaged by enemy small arms fire or returned fire that harmed civilians or Service Members. The Marines were suffering from concussion symptoms and traumatic brain injury (TBI) from the blast, disorientation from CS gas near the canal (from perforated canisters on the wounded), and the confusion created by outgoing warning shots/fire from several directions. U.K. Forces acknowledged they fired warning shots from two locations in vicinity of the Barron Hotel immediately after the explosion. A Marine with Recon

ACTS-SCK-DO

SUBJECT: Enclosure 7 - Executive Summary for Findings and Recommendation – Attack Against U.S. Forces Conducting Non-combatant Evacuation Operations (NEO) at Hamid Karzai International Airport on 26 August 2021

Company, 24th MEU observed a suspicious individual immediately before and after the blast. The Marine fired four warning shots over the head of the suspicious individual, who was at the southwest end of the canal, taking a position to observe the Marines' reaction to the attack, and the inner corridor of Abbey Gate.

(4) **The attack was not preventable at the tactical level without degrading the mission to maximize the number of evacuees.** According to those interviewed, the central task was NEO and maximizing the flow of civilian evacuees. Any methods implemented to prevent the attack would have required a significant reduction of evacuee flow or closure of the gate, which would have resulted in mission degradation. Gate closure would also have isolated U.K. forces at the Barron Hotel, greatly increasing risk to force and risk to mission. Reopening the gate and clearing crowds later for the U.K. forces would have created significant delays (specifically to the JTE) risked breach of the gate, and exposed Marines to greater risk. Leaders at the company and battalion level made prudent decisions, multiple times a day, under incredibly dynamic conditions to mitigate the threat and protect the force, without jeopardizing the mission. They lowered the Service Members' profile/posture and sought additional cover when threat reporting increased. Additionally, due to increased threat reporting on 26 August, and prior to the attack, medical assets were surged forward to the Abbey Gate. This included consolidation of Corpsmen behind cover, increased sniper overwatch, and emplacement of additional electronic counter measures. Leaders struck the balance of protecting the force and maximizing the flow of evacuees as best as possible under the circumstances.

(5) **The wounds sustained by the KIA were so catastrophic, none could be saved.** Medical providers at multiple echelons stated access to additional advanced treatment and equipment would not have saved more lives. The capability at HKIA's Role II-E saved several Service Members who otherwise would have succumbed to their wounds. Providers stated the capability at HKIA was the most robust they had experienced in an operational setting. Every Service Member who could have been saved with medical treatment survived due to the medical capability at HKIA.

### **3. Recommendations.**

a. **TBI Screening.** During the course of the investigation, it became apparent Service Members received inconsistent evaluation for concussion and TBI after the attack at Abbey Gate. Since the initial medical evacuation of the wounded, thirteen Service Members have been added to the list of those wounded in action; many for TBI. I therefore recommend forwarding findings and recommendations to all CENTCOM Service Component Commanders for consideration that all Service Members at Abbey Gate during the attack, and present in any blast zone depicted in exhibit 137, slide 7, and be evaluated for TBI.



ACTS-SCK-DO

SUBJECT: Enclosure 7 - Executive Summary for Findings and Recommendation – Attack Against U.S. Forces Conducting Non-combatant Evacuation Operations (NEO) at Hamid Karzai International Airport on 26 August 2021

**b. Mental Health Evaluation.** A consistent trend during interviews with young Marines were stories involving traumatic injuries and death of children, separation of families at gates, and outright rejection of evacuees culminating in their distraught return to the civilian population outside the gate. During the response to the attack at Abbey Gate, young Marines heroically recovered the wounded and rendered life-saving care. Others carried the bodies of their deceased friends away from the canal. In consideration of the mental and emotional strain placed on these young Marines and other Service Members, I recommend forwarding the findings and recommendations to all CENTCOM Service Component Commanders. Recommend mental health evaluations and treatment options for all personnel executing entry control point operations at Abbey Gate from 17-26 August. Evaluations and treatment options should also be pursued for personnel involved in the medical response to the attack on Abbey Gate on 26 August.

**c. Interagency NEO Doctrine.** Many leaders observed planning and execution with interagency partners was difficult, because there were no baseline concepts or shared understanding common to the various entities involved in the execution of NEO. To address this shortcoming, I recommend forwarding this investigation to the Joint Staff for consideration in drafting and publication of interagency doctrine for Non-combatant Evacuation Operations.

**d. Further Investigation.** During an interview with Platoon Commanders of Golf Company, 2/1 Marines, a Platoon Commander stated a civilian was killed by a flash bang grenade. The investigator did not pursue the line of questioning, because of the group setting and potential for misconduct and a rights advisement. After speaking with my legal advisor, I assessed this line of inquiry was outside my scope to investigate and would incur a significant delay in meeting my timeline and mandate. I recommend forwarding exhibits 84 and 128 to MARCENT for potential investigation into statements made by the Platoon Commander from Golf Company, 2/1 Marines, concerning a possible civilian casualty caused by use of a flash bang grenade.

5. The point of contact for this memorandum is the undersigned at [redacted] or

[redacted] (b)(3) 10 U.S.C. 130b, (b)(6)

[redacted] (b)(3) 10 U.S.C. 130b, (b)(6)

(b)(3) 10 U.S.C. 130b, (b)(6) LANCE G. CURTIS  
BG, USA  
Investigating Officer

ACTS-SCK-DO

SUBJECT: Enclosure 7 - Executive Summary for Findings and Recommendation –  
Attack Against U.S. Forces Conducting Non-combatant Evacuation Operations (NEO)  
at Hamid Karzai International Airport on 26 August 2021

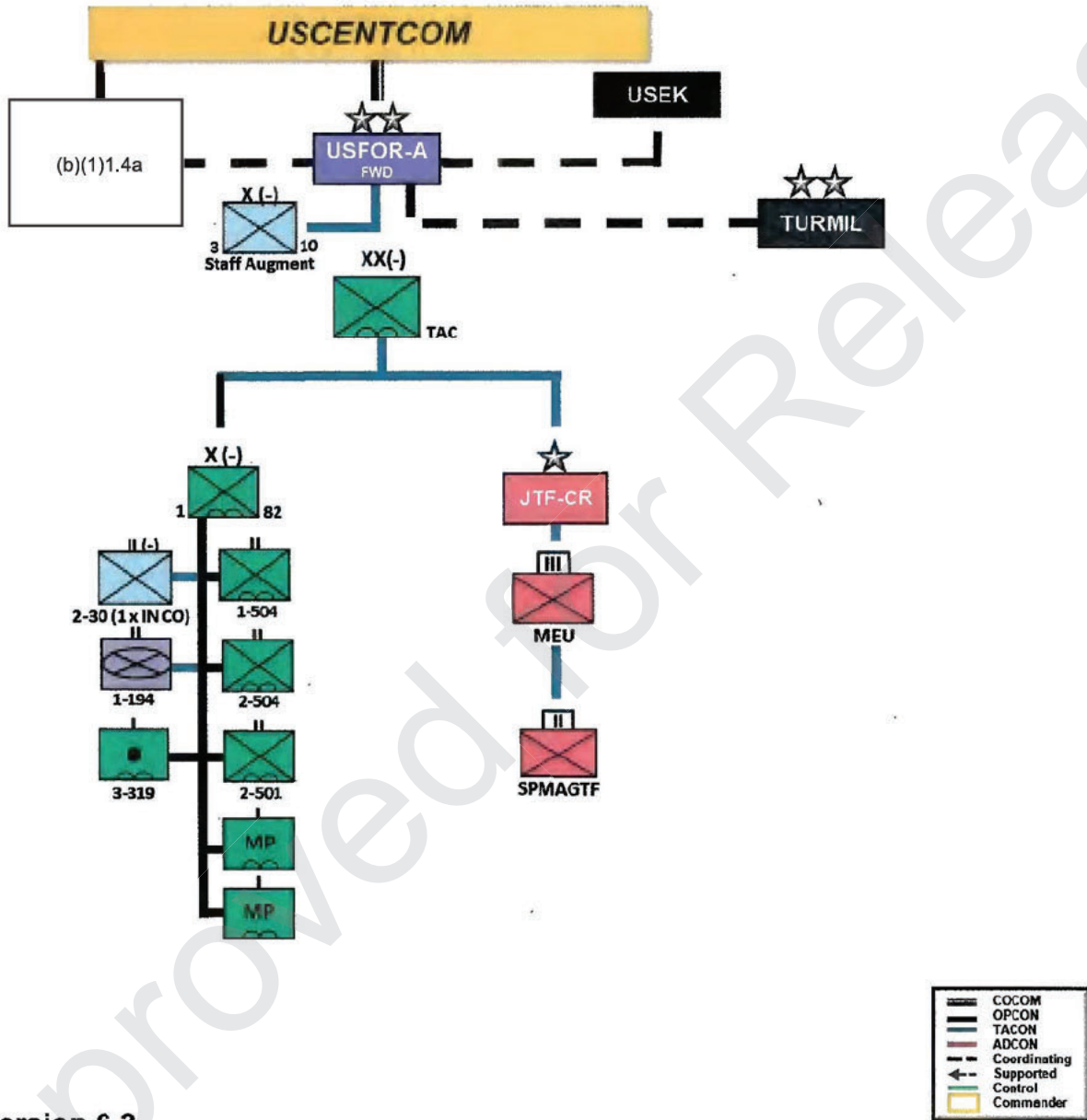

Version 6.3



SECRET//REL USA, FVEY

# Original COMREL (Version 6.3) 17AUG21

Enclosure 08

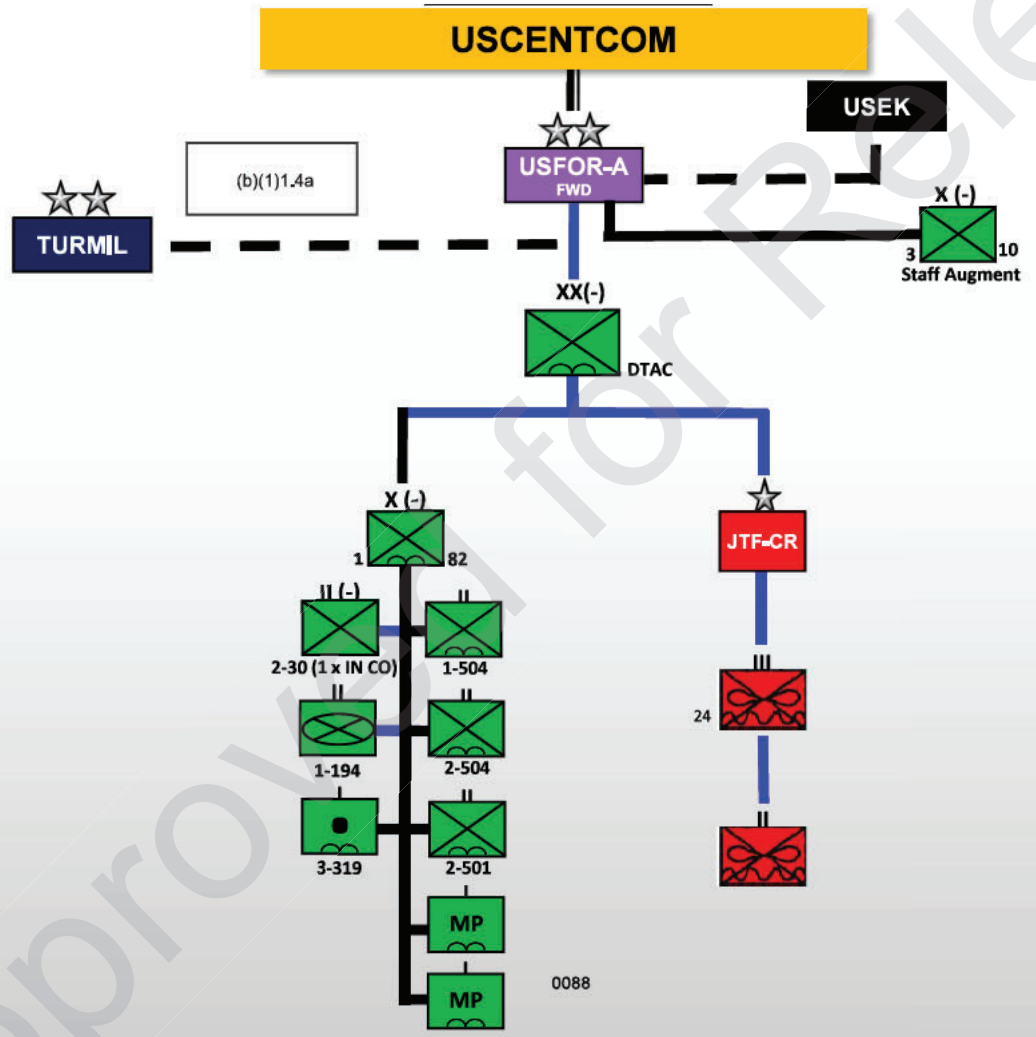

USCENTCOM FOIA 21-0545  
(Abbey Gate Investigation)

0088

02/02/22

SECRET//REL USA, FVEY

—	COCOM
—	OPCON
—	TACON
—	ADCON
- - -	Coordinating
· · ·	Supported
■	Control
■	Commander



SECRET//REL USA, FVEY

# Original COMREL (Version 6.3) USFOR-A FWD FRAGO 11—20AUG21

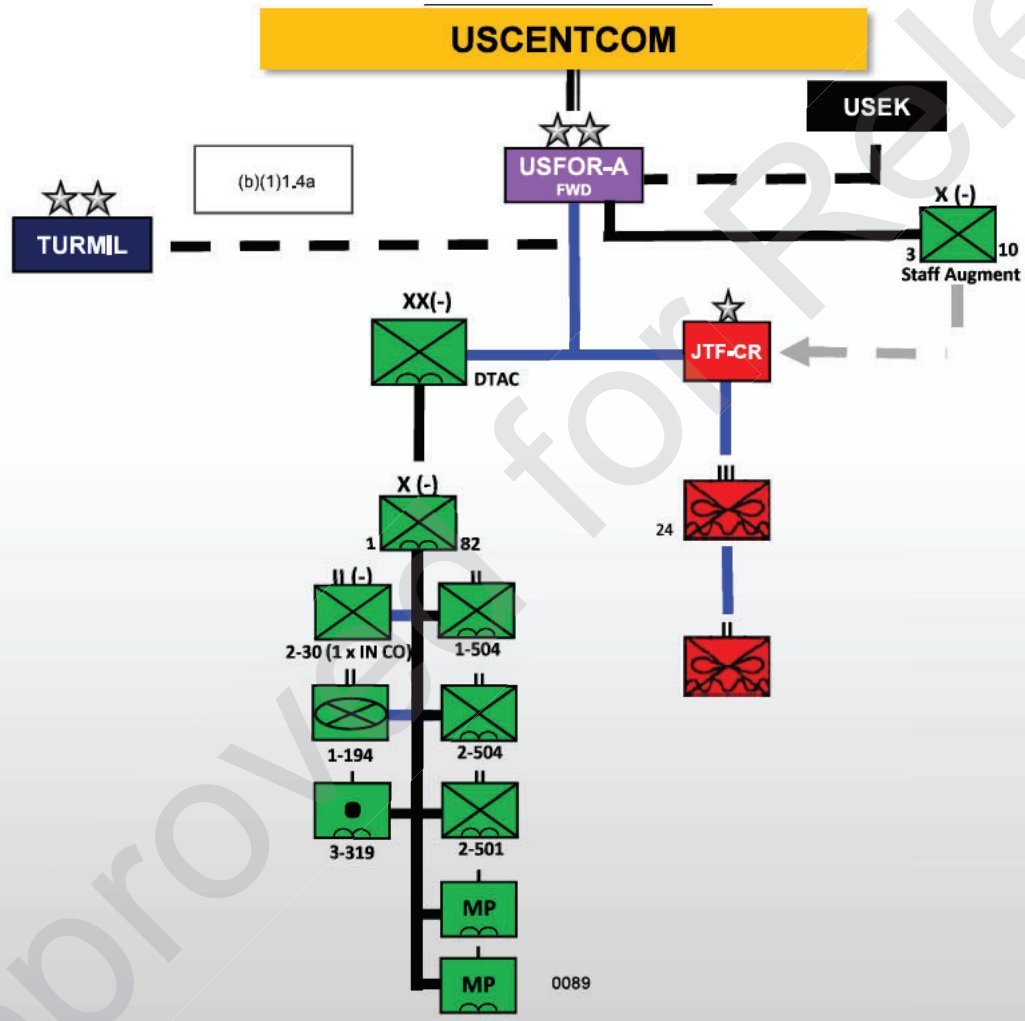

USCENTCOM FOIA 21-0545  
(Abbey Gate Investigation)

VERSION 6.3

0089

02/02/22

SECRET//REL USA, FVEY

—	COCOM
—	OPCON
—	TACON
—	ADCON
—	Coordinating
←	Supported
—	Control
—	Commander



SECRET//REL USA, FVEY

# Executed COMREL by 19AUG21

## USCENTCOM

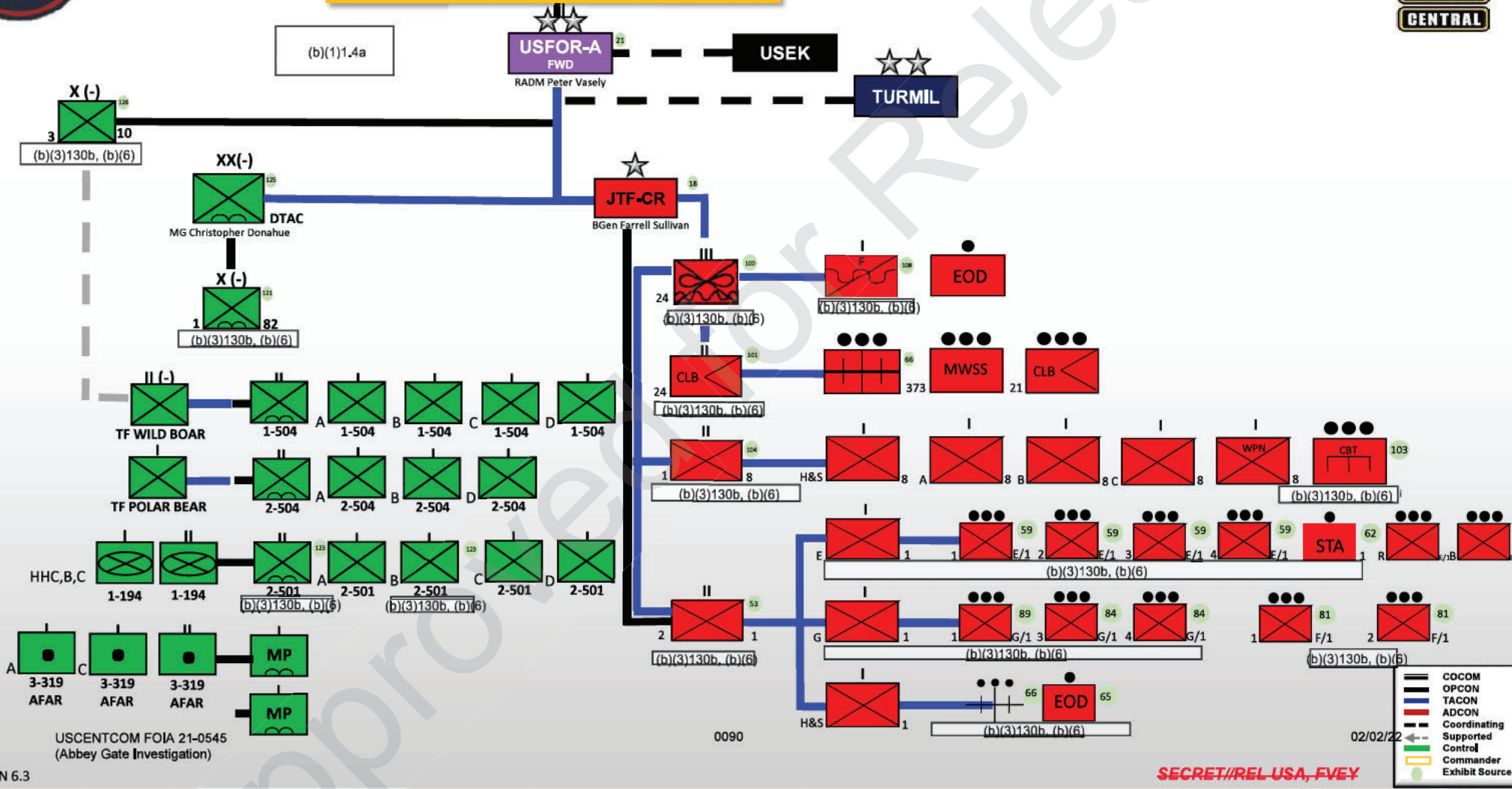

USCENTCOM FOIA 21-0545 (Abbey Gate Investigation)

Approved for Release



SECRET//REL USA, FVEY

# Executed JTF-CR COMREL by 19AUG21

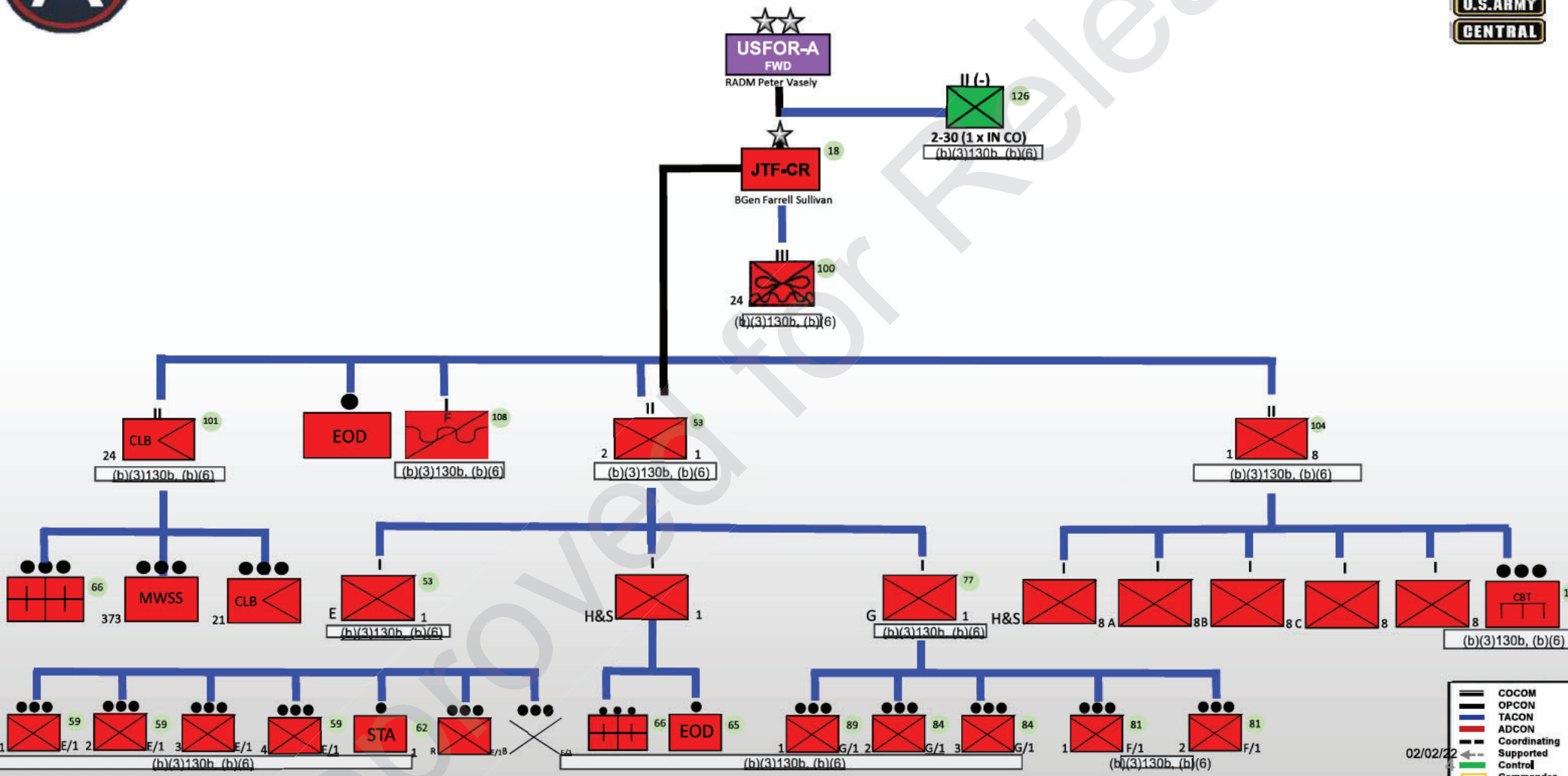

02/02/22

- COCOM
- OPCON
- TACON
- ADCON
- Coordinating
- Supported
- Control
- Commander
- Exhibit Source



# August Timeline of Key Events

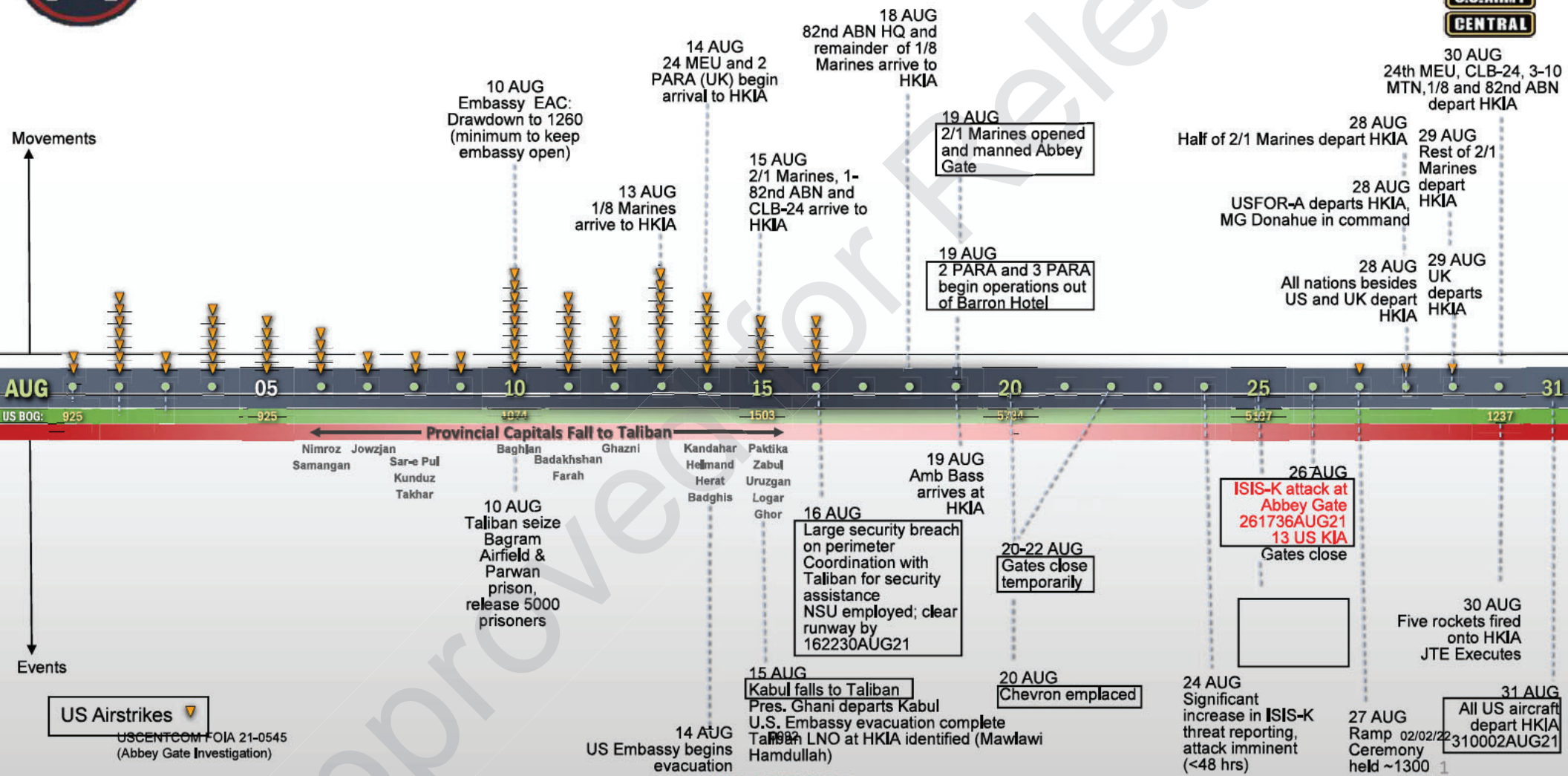



# 25 - 27 August Timeline of Key Events

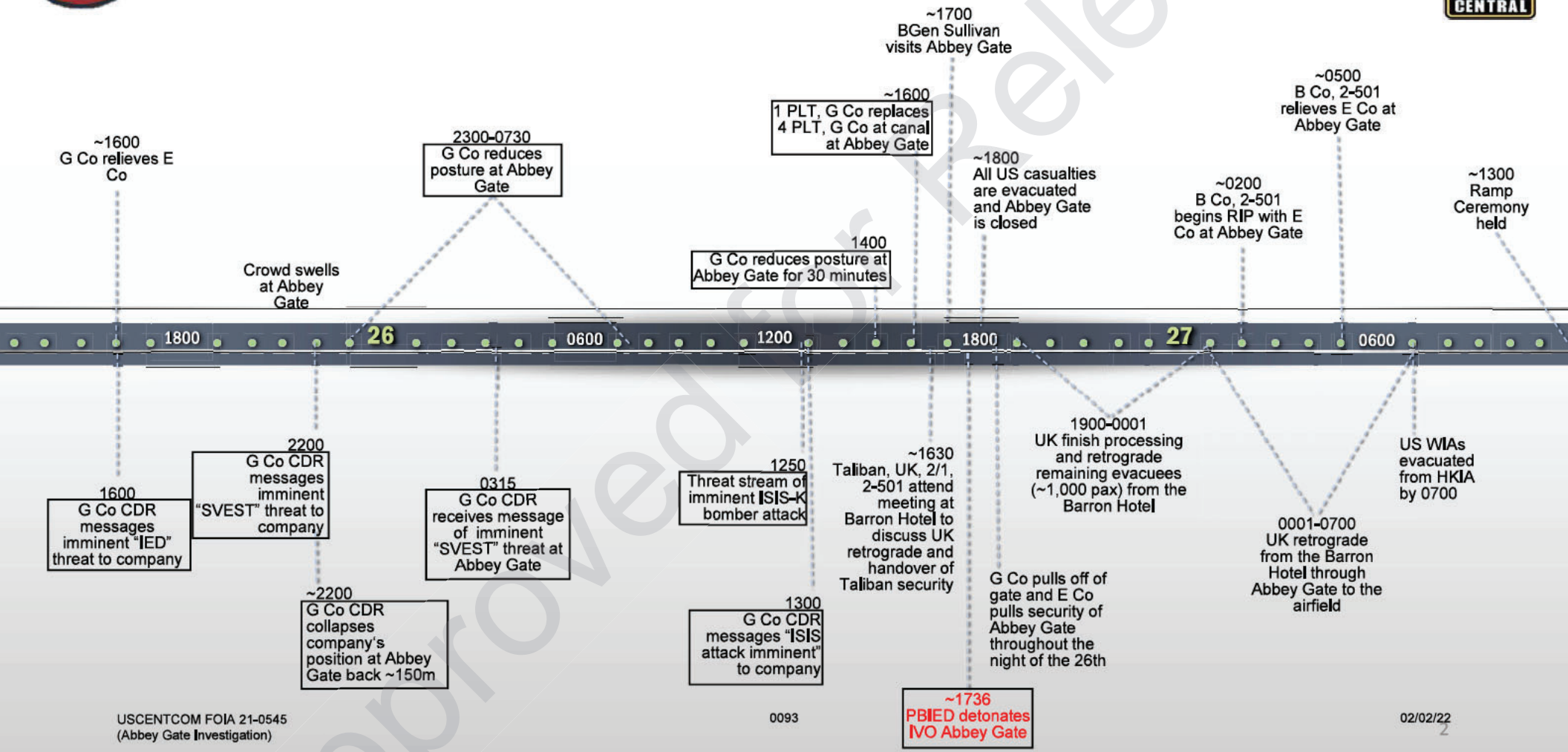



# Unit Locations at HKIA

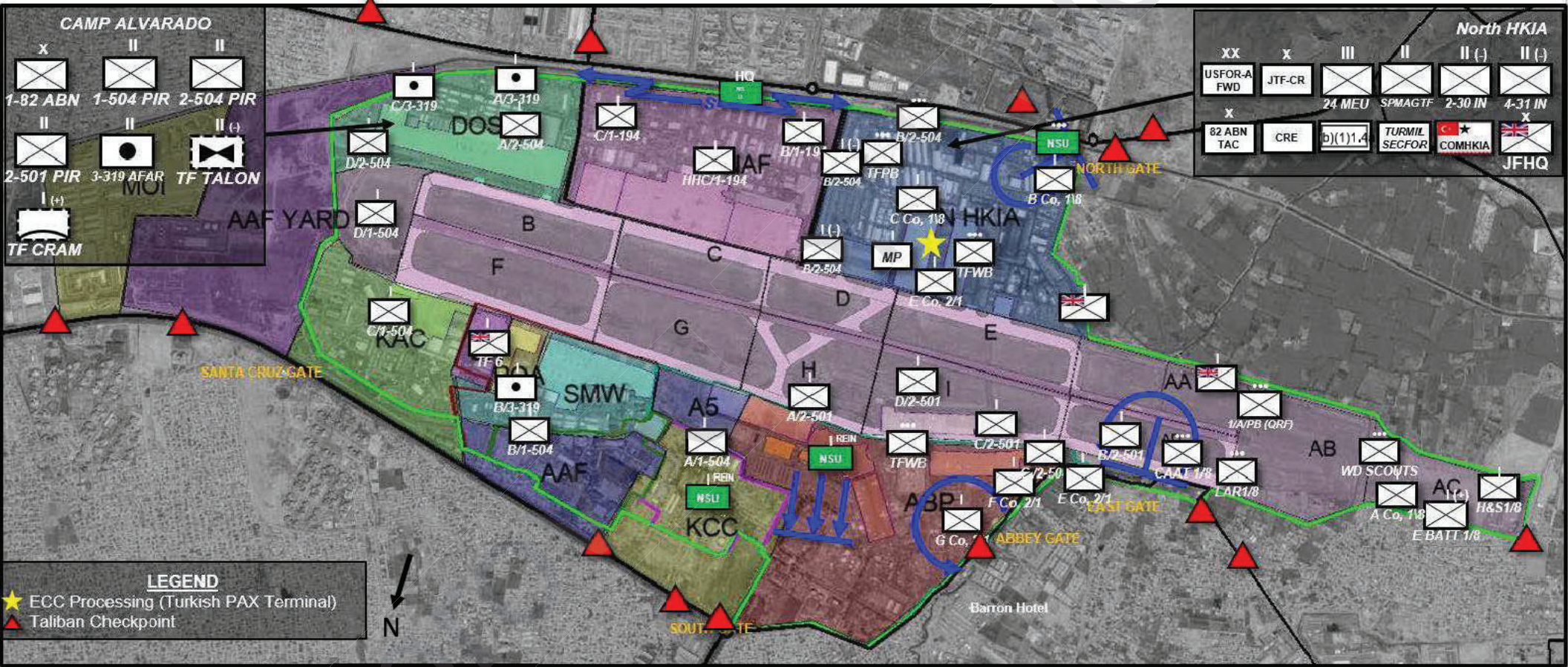

# Hamid Karzai International Airport

Key Locations, Orientation, and Crowd Size and Distance to U.S. and  
Allied Forces

PURPOSE AND INTENT  
All Open Source

- 1. First Slide is an example to show the “how” the pictures will be oriented further in the brief. It will identify the key landmarks to orient the reader and important location.
- 2. Next set of slides are for orientation of the airport to the city and surrounding areas. Although many of the pictures are simple Google Map overlaps that are outdated, this will help indicate where certain checkpoints and events took place such as Taliban Checkpoints and the relation to the airfield.
- 3. Later slides involve are accurate for landmarks and orientation, but not a 100% match to the conditions on the ground
- 4. Pictures from days before the incident to show crowd sizes, distance to service-members, and closer in time conditions (such as fence conditions, concertina wire, etc).
- 5. Pictures showing the exact location of the blast including post blast pictures.

Generic Google Map Photo (used for general orientation only)



 **Blast Location – Far side of canal (Barron Hotel side in front of Green Fence)**  
USCENTCOM FOIA 21-0545

UNCLASSIFIED - ~~FOUO~~

02/02/22



Generic Google Map Photo (used for general orientation only)



1. Slides shows zoomed in Southern side of airport and roads in/out to the airport and Abbey Gate.

 Blast Location - Far side of canal (Barron Hotel side in front of Green Fence) across from Abbey Gate Tower  
(Abbey Gate Investigation)

UNCLASSIFIED - ~~FOUO~~

02/02/22

Generic Google Map Photo (used for general orientation only)

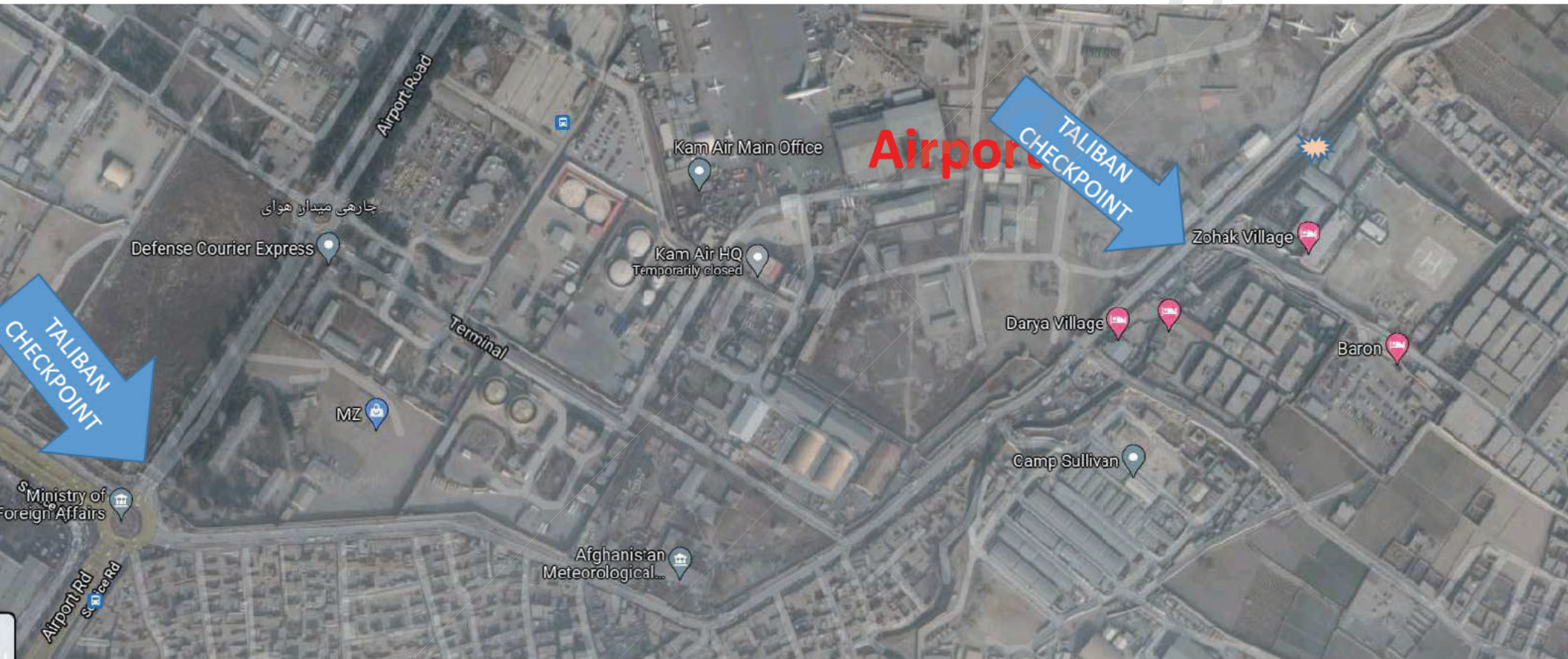

1. Slides shows zoomed in Southern side of airport and roads in/out to the airport and Abbey Gate. To the right, the circles will be used to show examples of Taliban checkpoints and traffic congestion.

Blast Location – Far side of canal (Barron Hotel side in front of Green Fence) across from Abbey Gate Tower

UNCLASSIFIED - FOUO

02/02/22

Generic Google Map Photo (used for general orientation only)

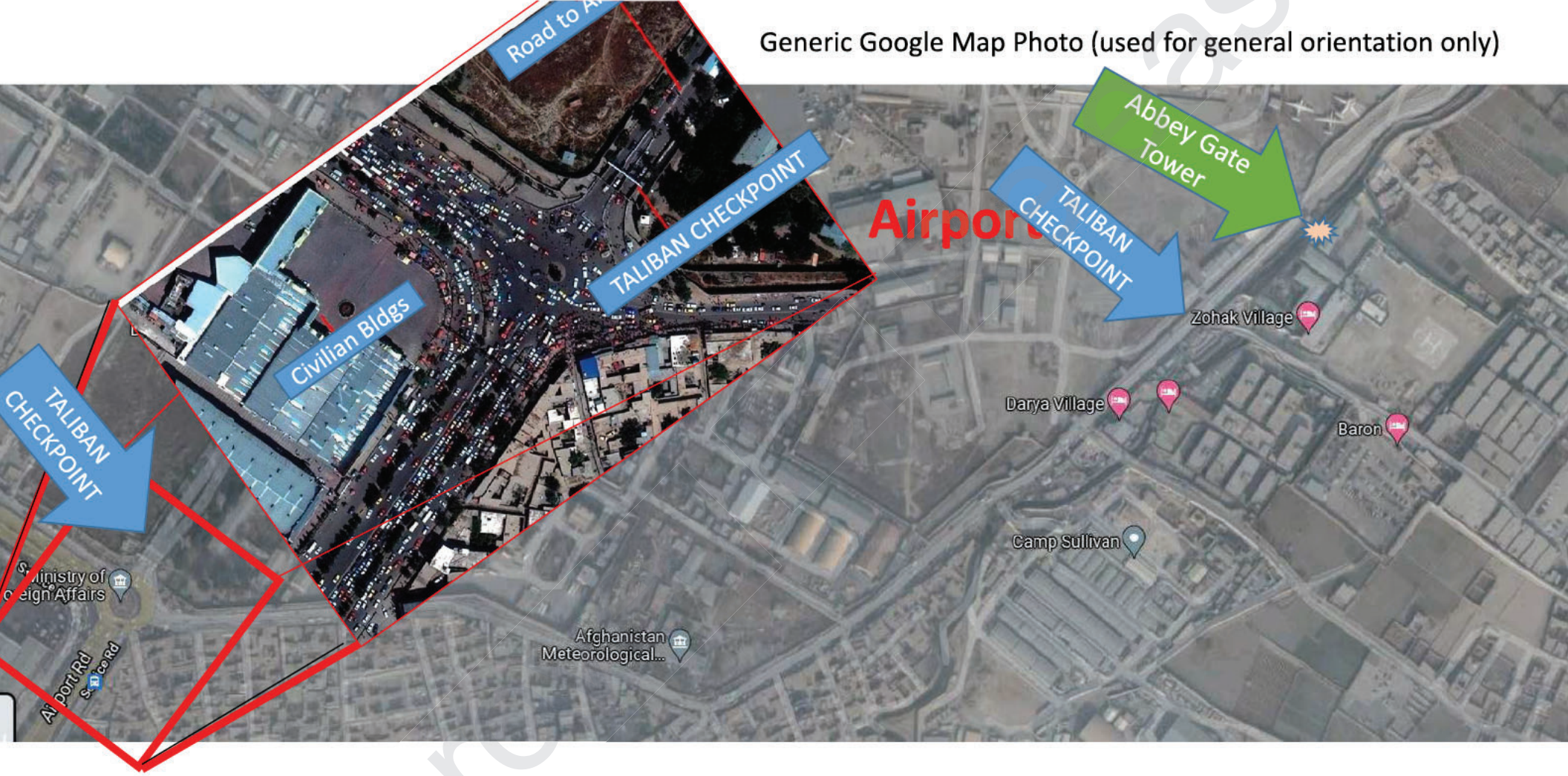

**Blast Location – Far side of canal (Barron Hotel side in front of Green Tower) across from Abbey Gate Tower**  
USCENTCOM FOIA 21-0545

UNCLASSIFIED - ~~FOUO~~



Generic Google Map Photo (used for general orientation only)

Zoom in view moving closer to Abbey Gate



Blast Location on Far side of canal (Barron Hotel side in front of Green Fence) across from Abbey Gate Tower  
(Abbey Gate Investigation)

UNCLASSIFIED - ~~FOUO~~

02/02/22

Generic Google Map Photo (used for general orientation only)



1. Zoomed in overview showing building locations and landmarks





Blast Location on Far side of canal (Barron Hotel side in front of Green Fence) across from Abbey Gate Tower  
(Abbey Gate Investigation)

UNCLASSIFIED - ~~FOUO~~

02/02/22

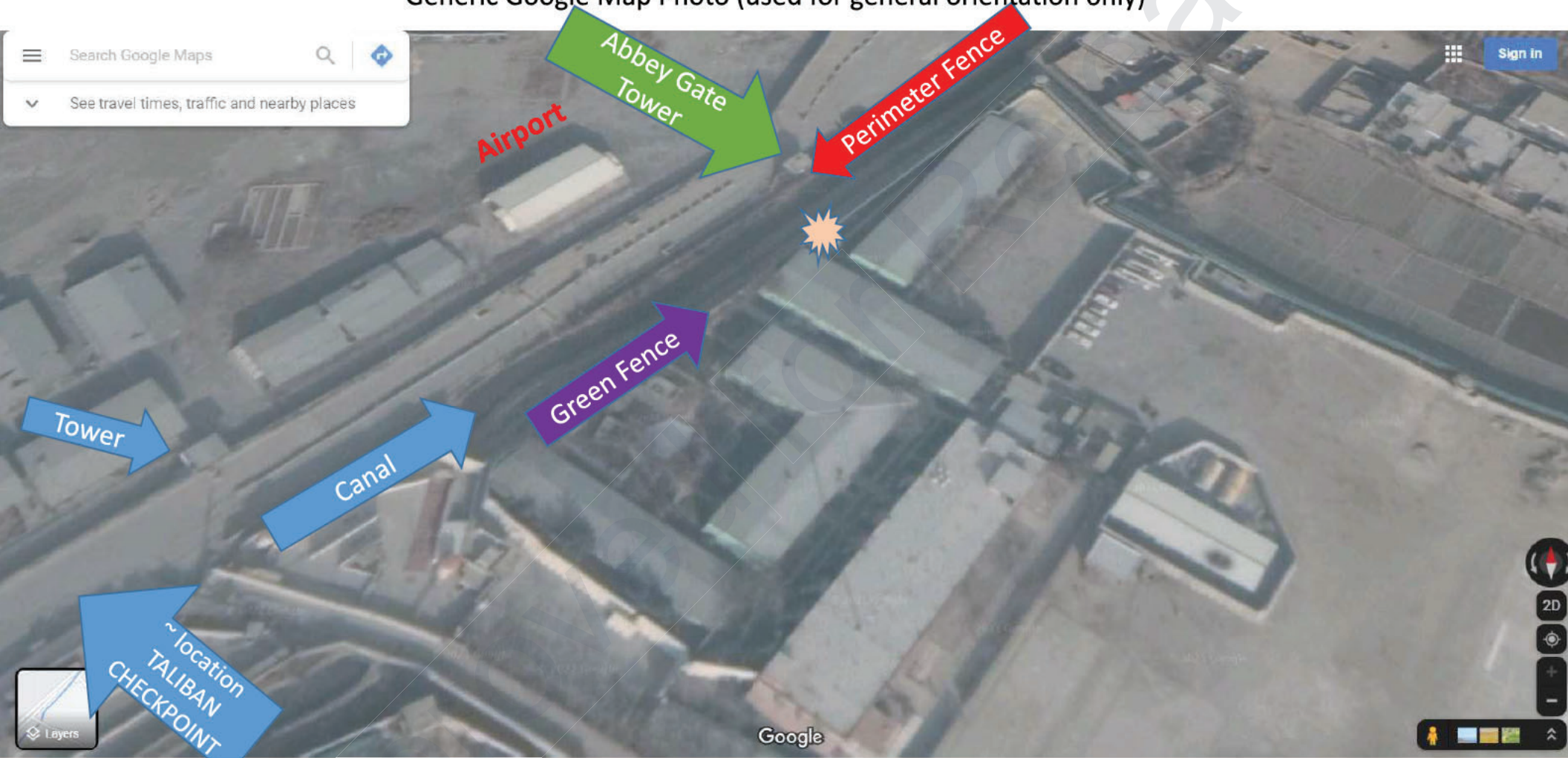
Generic Google Map Photo (used for general orientation only)



 Blast Location on Far side of canal (Barron Hotel side in front of Green Fence) across from Abbey Gate Tower  
(Abbey Gate Investigation)

UNCLASSIFIED - ~~FOUO~~

02/02/22

Generic Google Map Photo (used for general orientation only)



1. USCENTCOM FOIA 21-0545 (Abbey Gate Investigation)

0105



Blast Location – Far side (Barron Hotel side) of canal across from Abbey Gate Tower



USCENTCOM FOIA 21-0545  
(Abbey Gate Investigation)

ACROSS RELEASE



1. Note crowd sizes coming through cut throughs on the left.

2. Perimeter Fence is solid on the left of the Abbey Gate Tower but either non-existent or chain link to the right

Generic Google Map Photo (used for general orientation only)



Perimeter Fence is solid on the left of the "Abbey Gate Tower" but either non-existent or chain link to the right

Blast Location – Far side (Barron Hotel side) of canal across from Abbey Gate Tower

1. Perimeter Fence is solid on the left of the "Tower at Fence," but either non-existent or chain link to the right

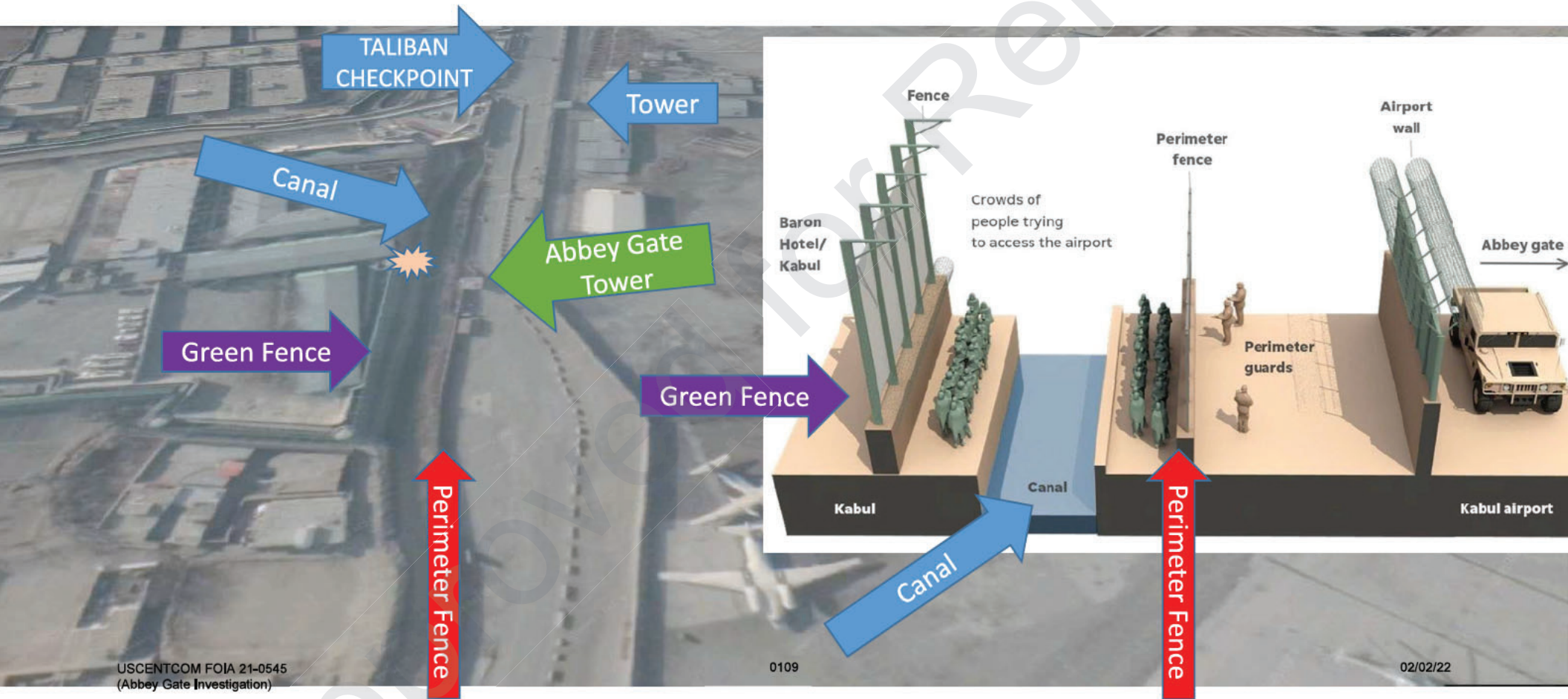



Case

1. ~ time if after airport surge on 14 Aug but prior to blast
2. Many of individuals have "papers" of some sort
3. Service-members on the right edge

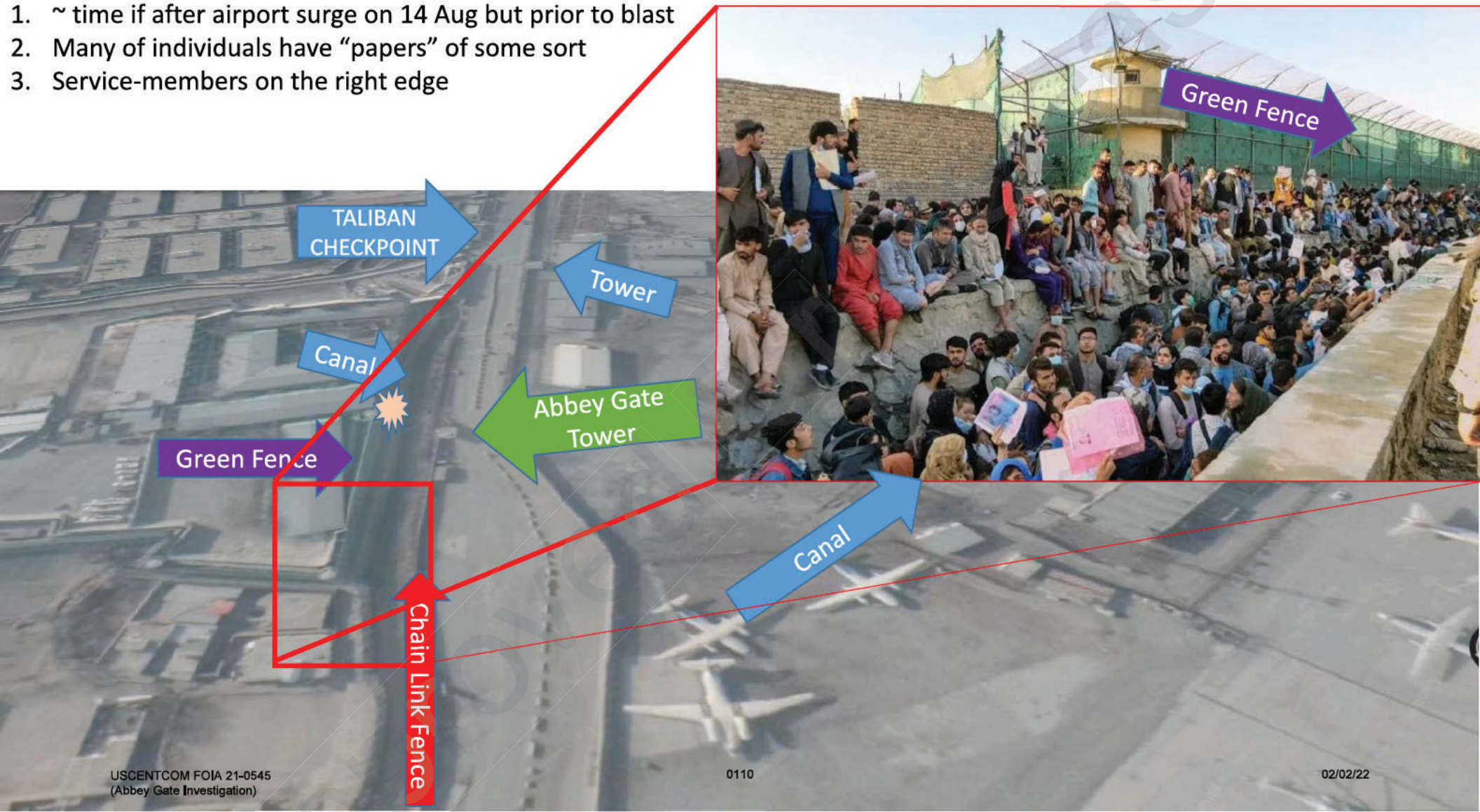

Abbey Gate

se

- 1. Concertina Wire added after surge
- 2. Megaphone next to Marines for announcements
- 3. Everyone has "papers"

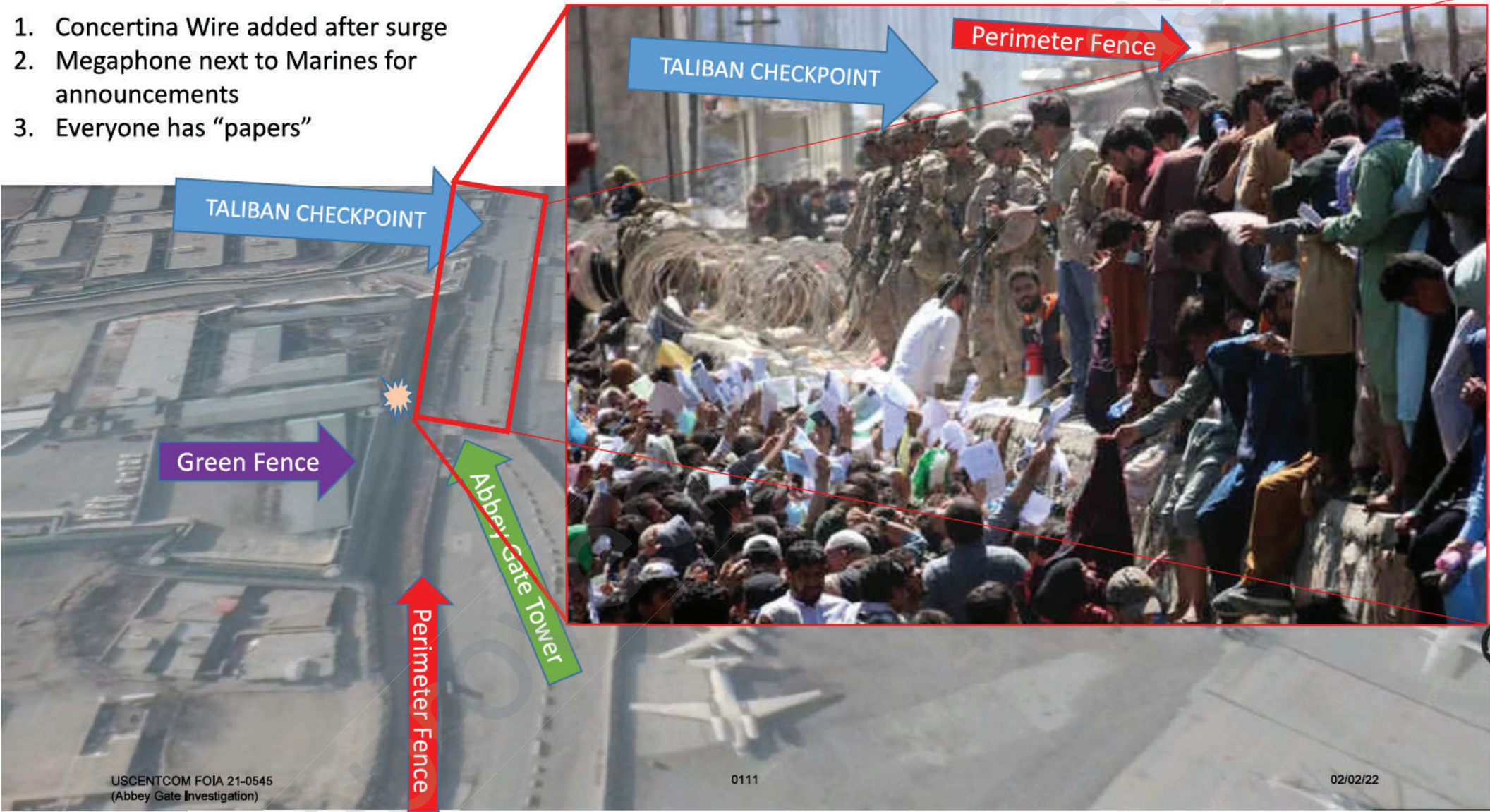

Abbey Gate



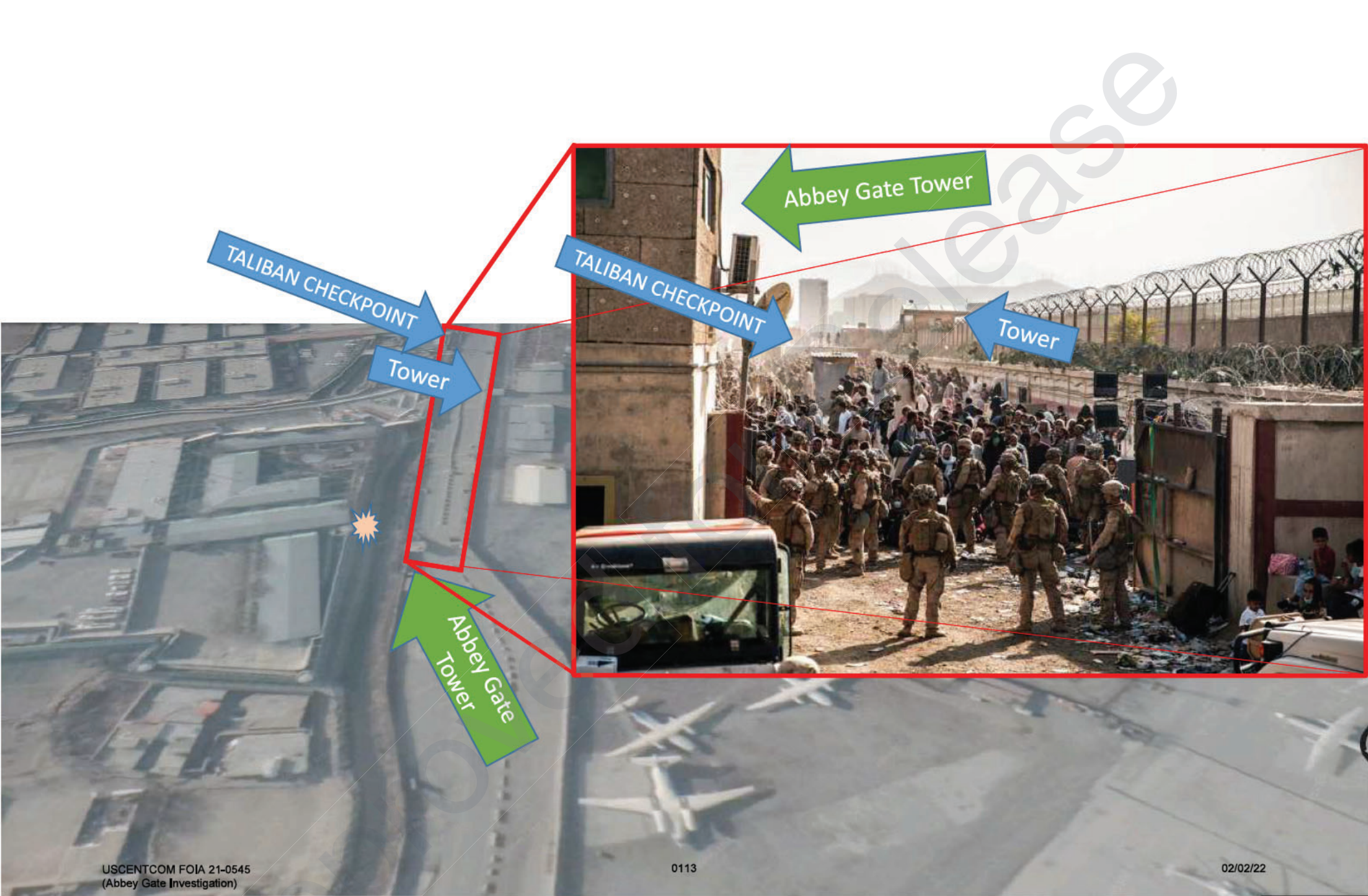

TALIBAN CHECKPOINT

Tower

Abbey Gate Tower

Abbey Gate Tower

TALIBAN CHECKPOINT

Tower

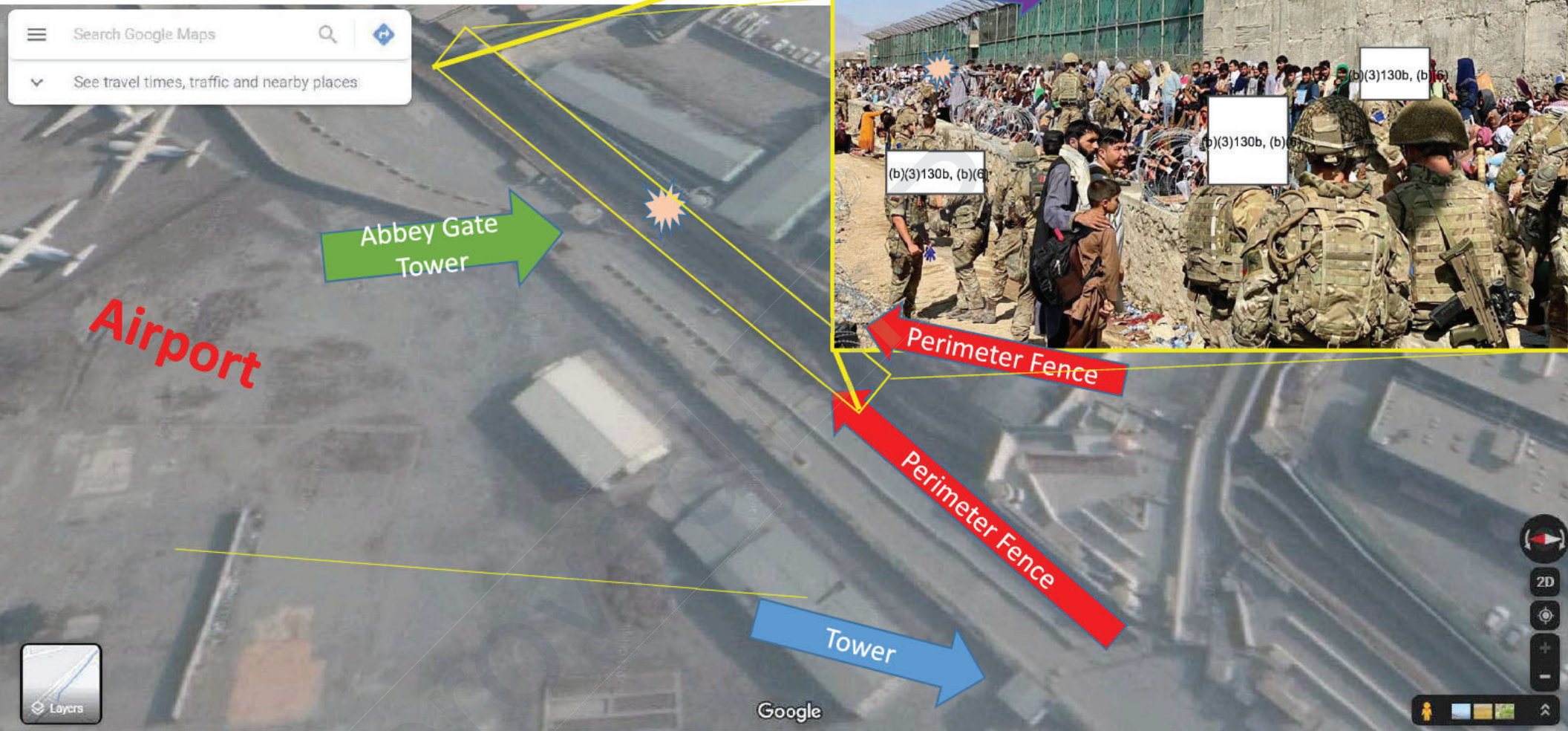

Perimeter Fence is solid on the left of the "Abbey Gate Tower" but either non-existent or chain link to the right

UNCLASSIFIED FOUO 0114



Blast Location – Far side (Barron Hotel side) of canal across from Abbey Gate Tower

Abbey Gate Investigation

se



Enlarged area

Approx. location of explosion

Baron Hotel

Abbey Gate Tower

Shipping containers used as a blockade to funnel people through checkpoint.

Crowds

Shipping container blockade

Road towards main entrance

ACR

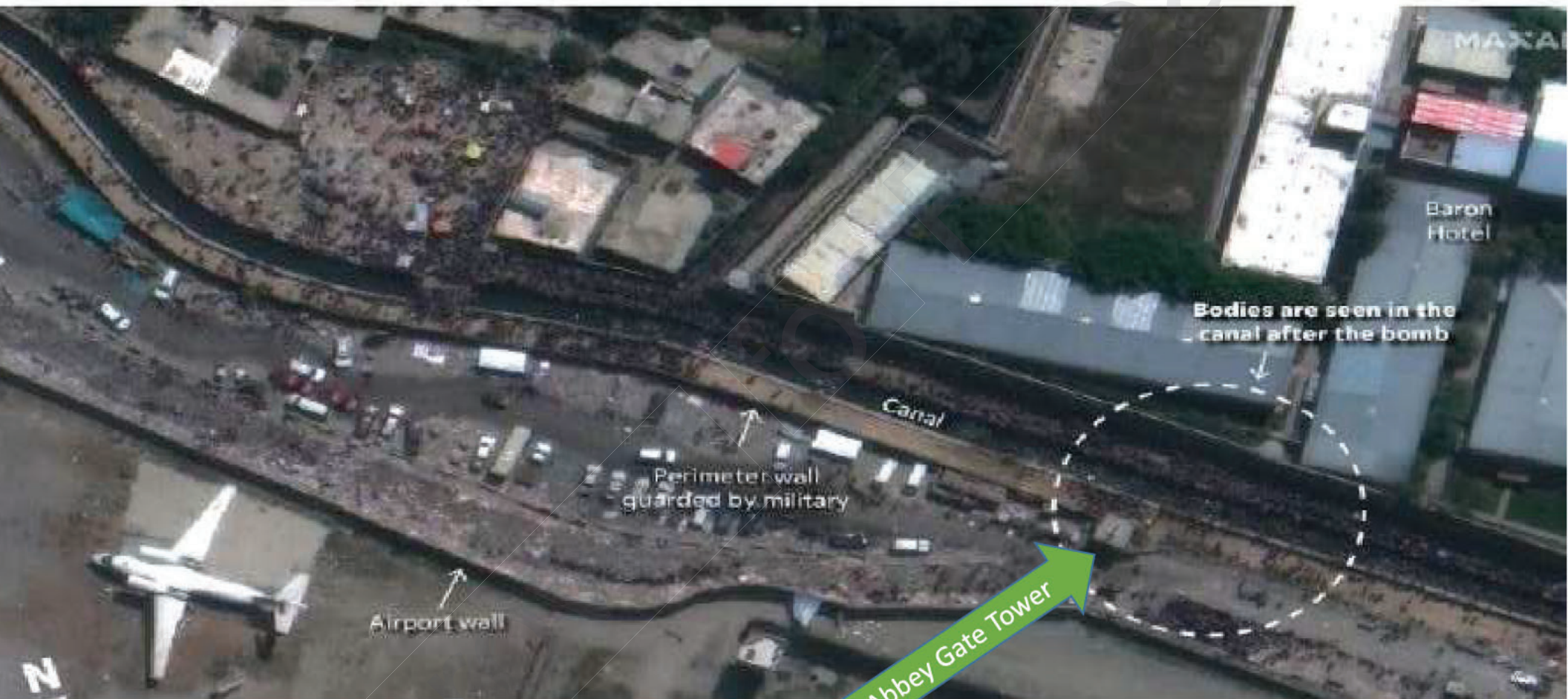



1. Approximate vantage (a little to the right) of SVEST facing Abbey Gate







USCENTCOM FOIA 21-0545  
(Abbey Gate Investigation)

0118

02/02/22





Page 68 redacted for the following reason:

-----  
(b)(1)1.4c

Approved for Release

Page 69 redacted for the following reason:

-----  
(b)(1)1.4c, (b)(6)

Approved for Release

Page 70 redacted for the following reason:

-----  
Enclosure 14 (b)(1)1.4c, (b)(6)

Approved for Release